



Federal
Public Service
FINANCE

NATIONAAL FORUM - OPEN FORUM - FORUM NATIONAL

PROCESSUS MASP – MASP PROCESSEN

25/01/2022



MASP SUPPORT

Wie contacteren? / Qui contacter?

@Helpdesk

VS

@Economic Support

Da.mf.es@minfin.fed.be

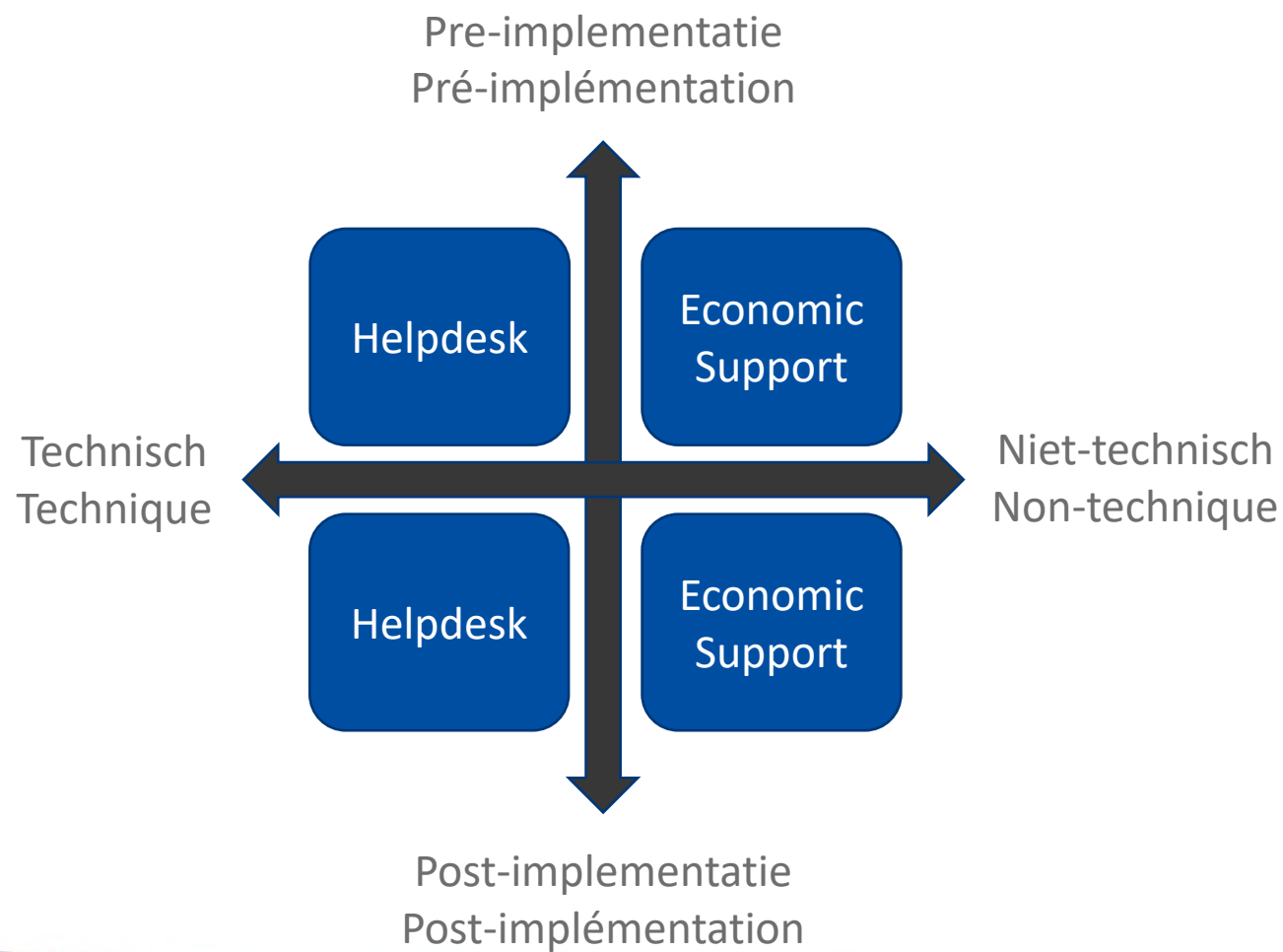



Federal
Public Service
FINANCE



PN-TS SYSTEM

PRESENTATION NOTIFICATION
TEMPORARY STORAGE DECLARATION
GOODS ACCOUNTING

Joelle Lauwers & Yves Arys
Customs & Excise
Information management

25/1/2022

WWW.FIN.BELGIUM.BE

CUSTOMS AND EXCISES • FEDERAL PUBLIC SERVICE FINANCE

.be



AGENDA

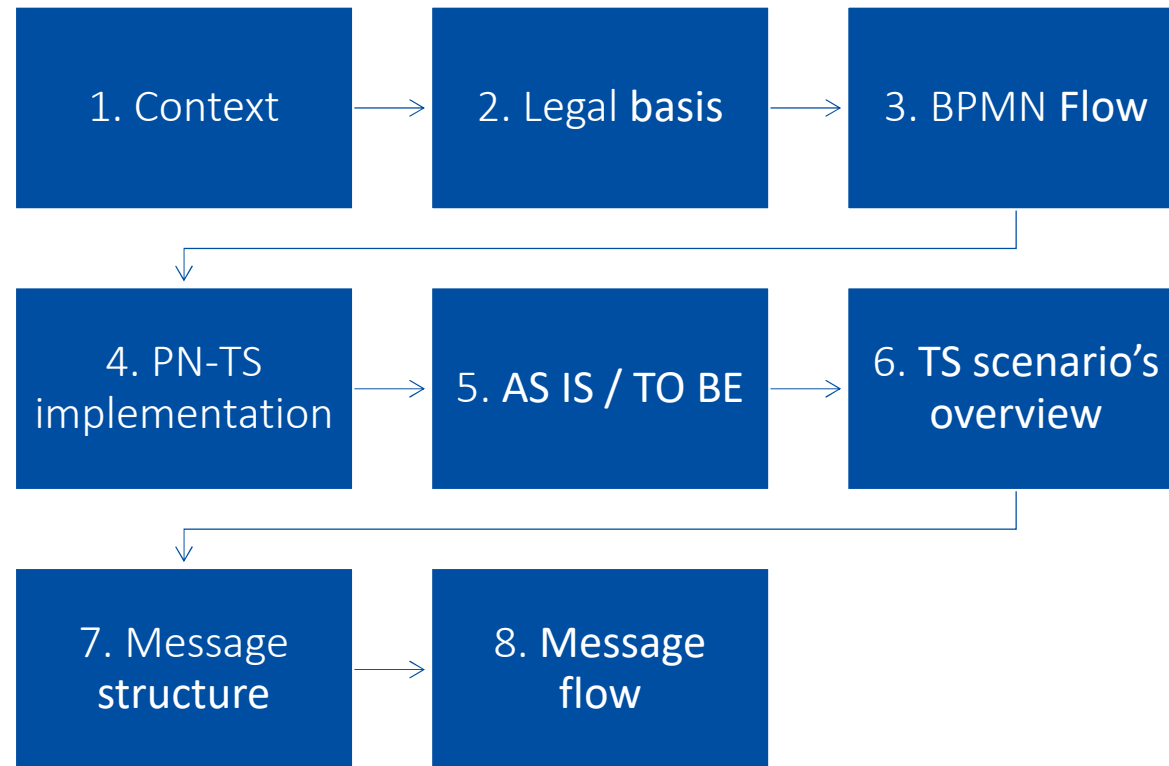



1. CONTEXT

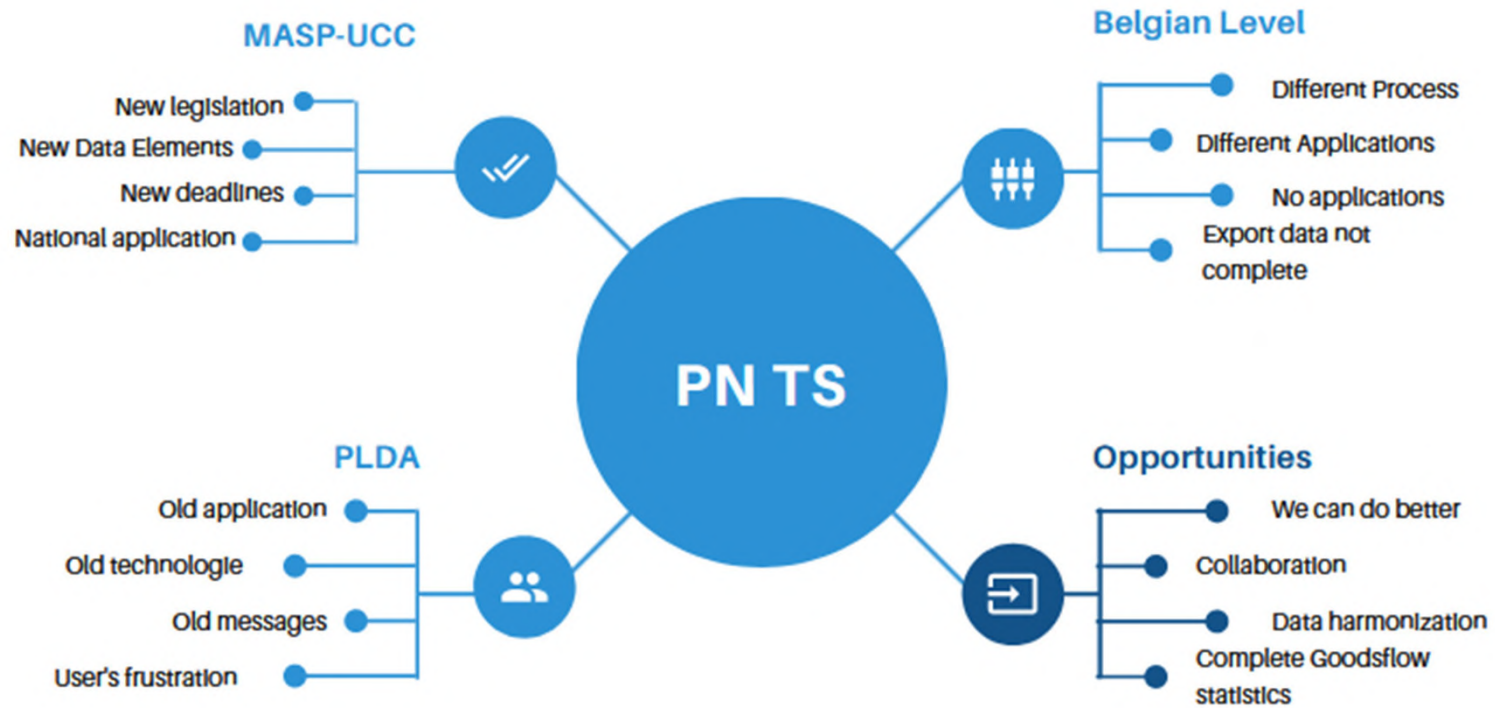



2. LEGAL BASIS (1/3)

- Presentation Notification

- *Art. 139 UCC: Presentation upon arrival or unloading in the EU customs territory*
« Goods brought into the customs territory of the Union shall be **presented to customs immediately upon their arrival** at the designated customs office or any other place designated or approved by the customs authorities... »
« Goods which are brought into the customs territory of the Union by sea or air and which remain on board the same means of transport for carriage, shall be **presented to customs only at the port or airport where they are unloaded or transhipped.** »
- *Art. 141 UCC: Presentation within transit procedure*
« ... shall not apply when **goods already under a transit procedure** are brought into the customs territory of the Union. »
- *Art. 145 UCC: Presentation within temporary storage procedure*
« The temporary storage declaration may be used also for the purpose of ... the presentation of the goods to customs referred to in Article 139, insofar as it fulfils the conditions laid down in those provisions. »



2. LEGAL BASIS (2/3)

- Temporary Storage Declaration

- *Art. 145 UCC :*

- *« Non-Union goods presented to customs shall be covered by a temporary storage declaration containing all the particulars necessary for the application of the provisions governing temporary storage. »*
- *« Customs authorities may accept that the temporary storage declaration also takes one of the following forms: a reference to any entry summary declaration lodged for the goods concerned, supplemented by the particulars of a temporary storage declaration ... »*
- *« ...where non- Union goods moved under a transit procedure are presented to customs at an office of destination within the customs territory of the Union, the particulars for the transit operation concerned shall be deemed to be the temporary storage declaration, provided they meet the requirements for that purpose. However, the holder of the goods may lodge a temporary storage declaration after the end of the transit procedure. »*



2. LEGAL BASIS (3/3)

- End of temporary Storage

- *Art. 149 UCC : « Non-Union goods in temporary storage shall be placed under a customs procedure or re-exported within 90 days. »*
- *Art. 115 UCC DA: Temporary storage in an approved place
« ...the goods are declared for a customs procedure or are re-exported no later than 3 days after their presentation or no later than 6 days after their presentation in the case of an authorised consignee»*



3. BPMN L3 FLOW (1/2)

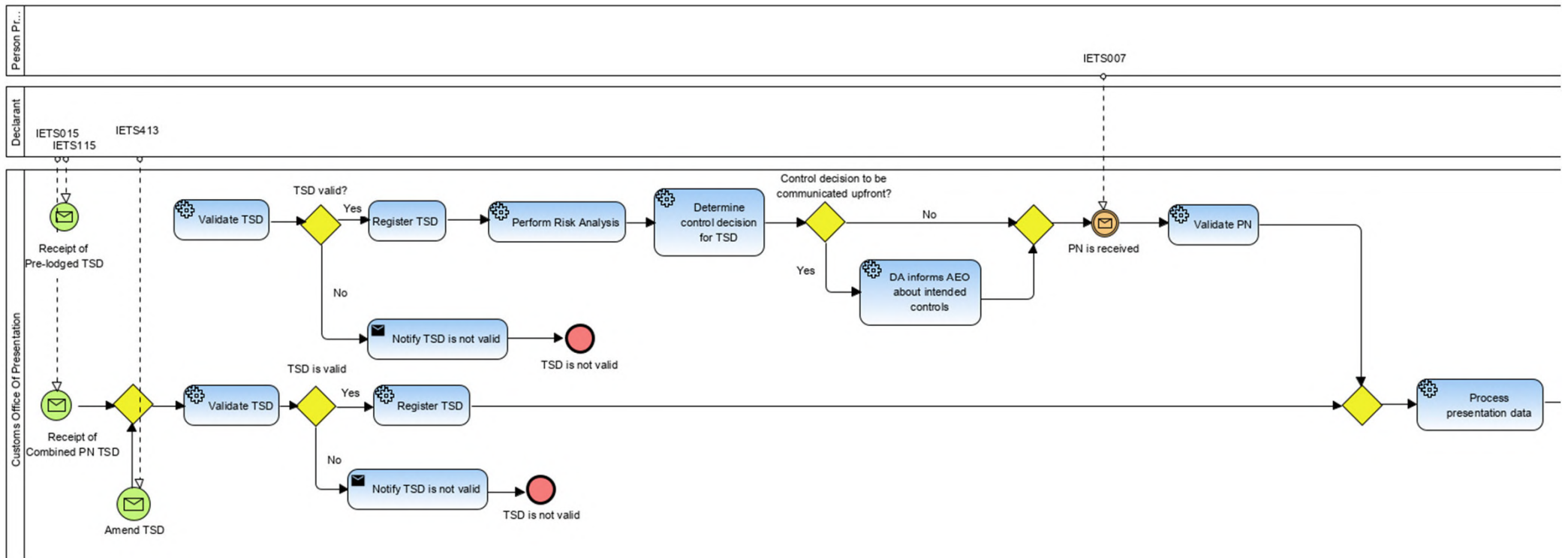



3. BPMN L3 FLOW (2/2)

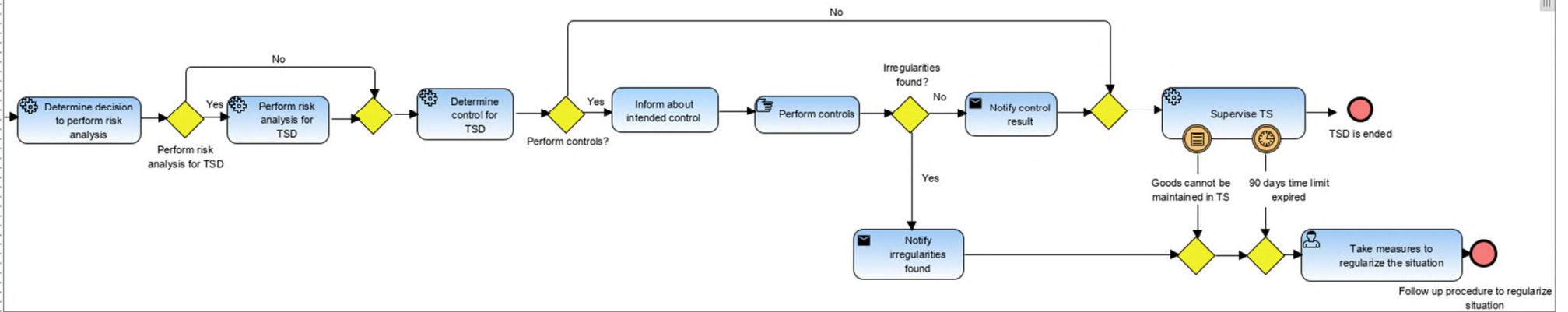



4. PN-TS IMPLEMENTATION (1/2)

- In scope:
 - Presentation upon entry: **submission and revocation of PN (G3)**
 - Not needed when lodged together with a temporary storage declaration
 - Not needed in case of transit
 - Placement under TS: **submission, amendment and invalidation of TSD (G4)**
 - Lodged before presentation of goods → activated with PN upon presentation
 - Lodged upon presentation of goods → combined dataset
 - ENS data can be re-used in both cases → only minimal TSD dataset needed
 - External transit declaration → no separate TSD needed (but allowed)
 - End of temporary storage and **goods accounting**
 - TS timer monitoring
 - Transfer to another TSF
 - Write-off with subsequent declaration
 - Temporary storage reporting (= facilitation)
 - Notification to EO
- Not in scope:
 - Notification of arrival of the means of transport (G2) → ICS2
 - Notify presentation in case of pre-lodged customs declaration → export (C2), transit (D4), import (I2)
 - Prove the Union status of goods → PoUS
 - Transfers not allowed within authorisation for temporary storage → transit



4. PN-TS IMPLEMENTATION (2/2)

- Legal deadline: 1/1/2023
- Proposal to follow a **phased approach**, aligning with ICS2 deadlines (to be confirmed)
 - 1/3/2023 - 1/10/2023: air cargo, express and postal
 - 1/3/2024 - 1/10/2024: maritime, rail and road
 - Earlier on voluntary basis
- Provisional message implementation guidelines available
 - PN (IETS007)
 - Pre-lodged TSD (IETS015)
 - Combined TSD (IETS115)
 - TSD amendment request (IETS413)
 - TSD invalidation request (IETS414)
- Remaining message specifications to be published soon (transit re-use, transfers, ...)
- Web application will be made available



5. AS IS / TO BE (1/2)

AS IS

TO BE

Unified solution

Local systems, limited to sea ports and Brucargo

One solution for all temporary storage in Belgium

UCC compliant solution

Current solution not UCC proof

System meeting new legal requirements set by UCC

Harmonized solution

Different solutions across Member States

Harmonized system specifications, shared with all Member States

Future-proof solution

Current solution not compatible with new customs IT landscape

Integration with new customs systems



5. AS IS / TO BE (2/2)

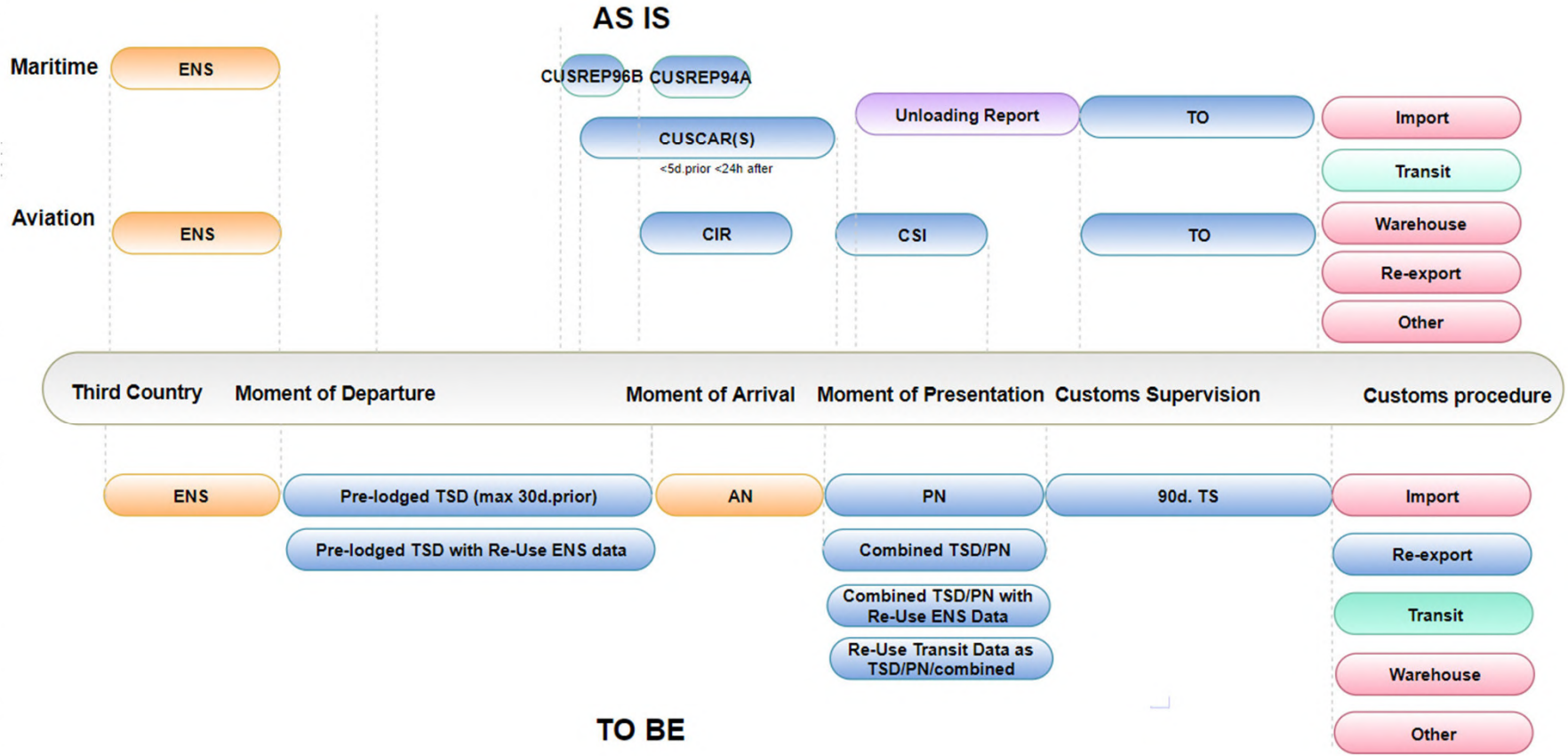



6. SCENARIO 1

BE = FIRST ENTRY, UNLOADING AT (AIR)PORT, NO TRANSFER

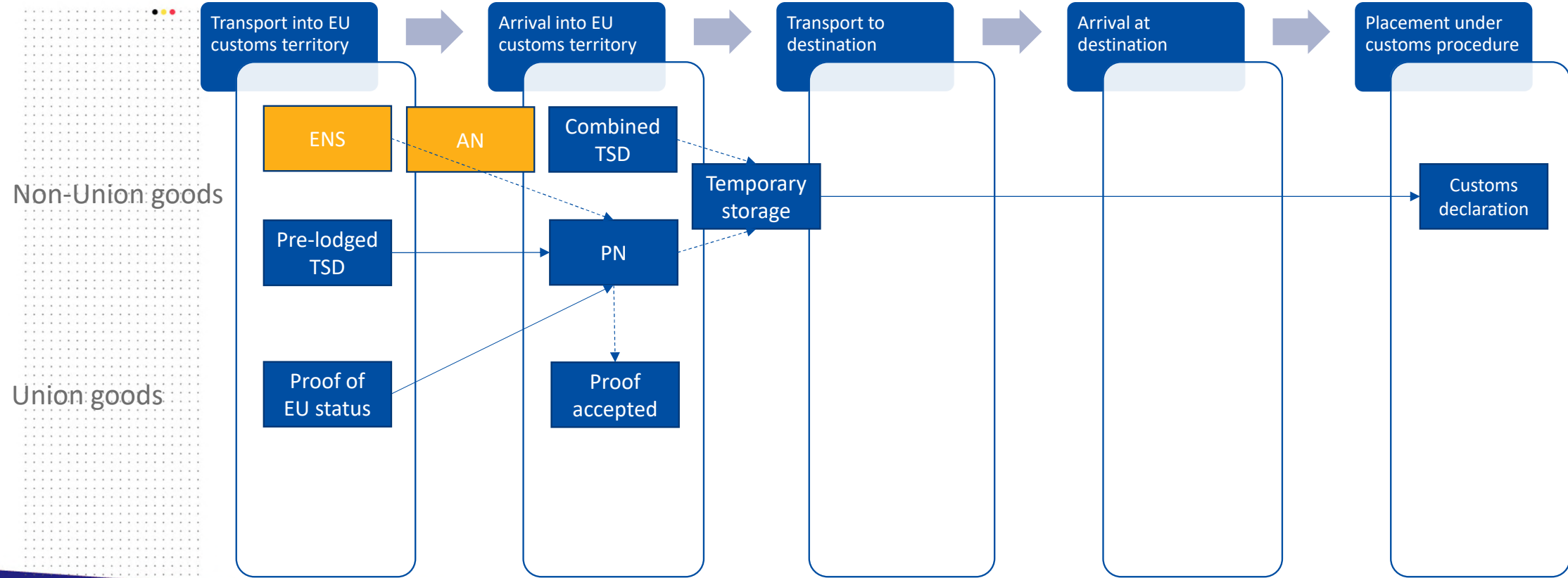



6. SCENARIO 2

BE = FIRST ENTRY, UNLOADING AT (AIR)PORT, TRANSFER TO TSF2

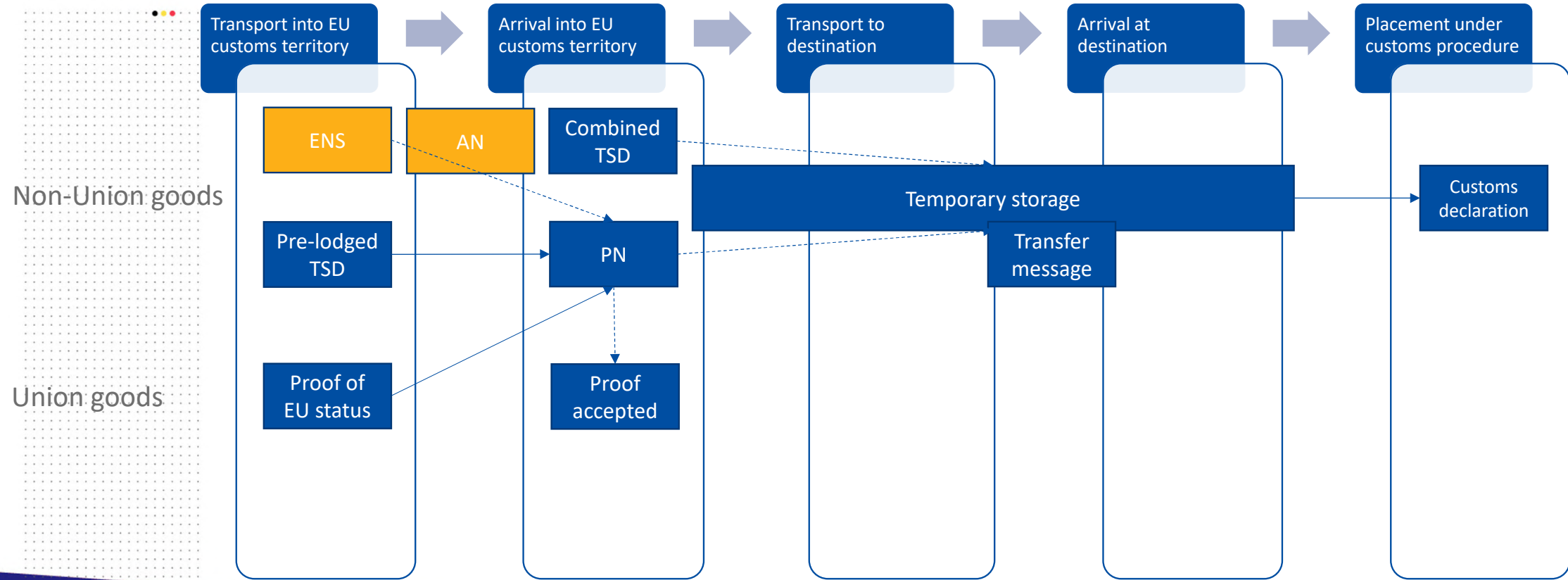



6. SCENARIO 3

BE = FIRST ENTRY, UNLOADING AT (AIR)PORT IN BE, TRANSIT TO TSF2

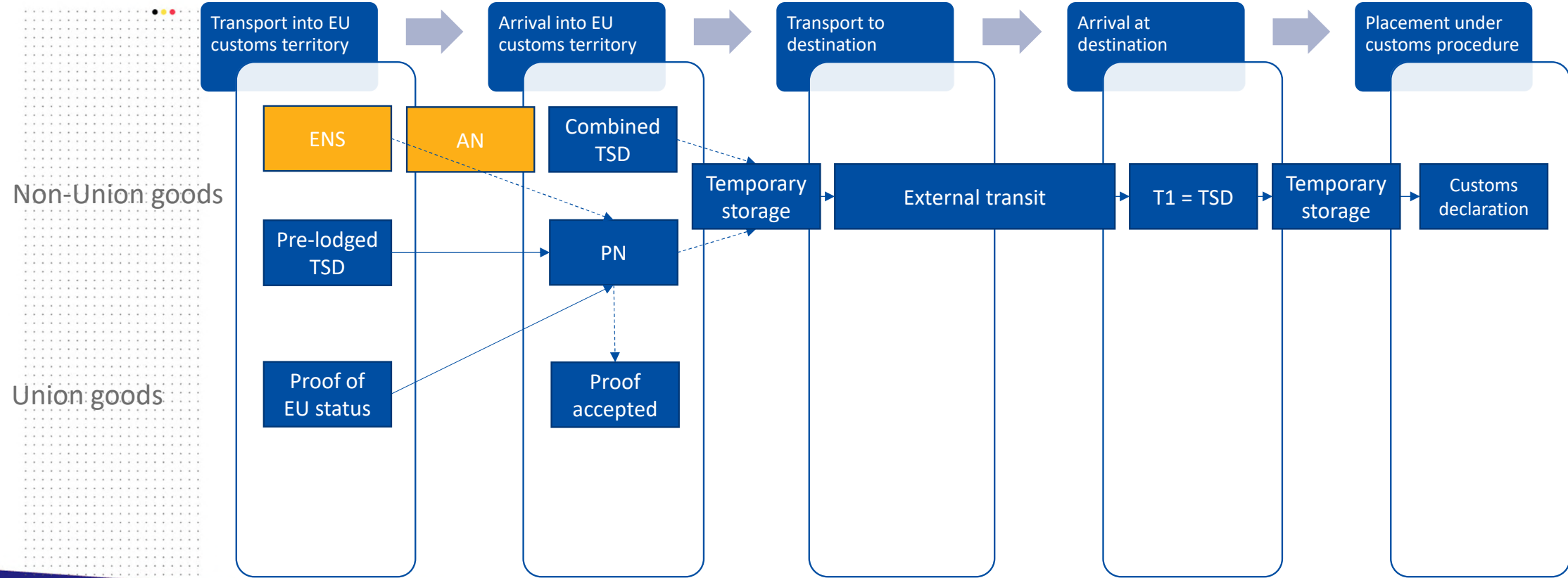



6. SCENARIO 4

BE = SUBSEQUENT ENTRY, UNLOADING AT (AIR)PORT OR INLAND

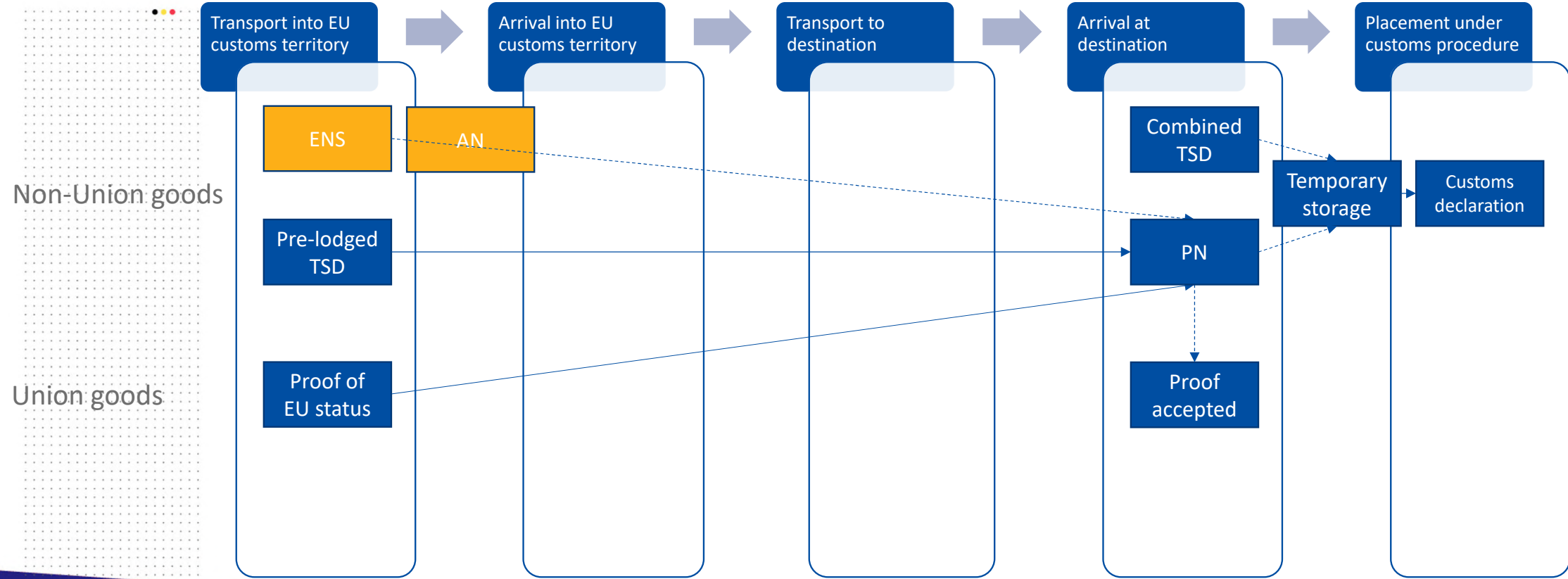



6. SCENARIO 5

ENTRY IN BE VIA TRANSIT, BE = DESTINATION

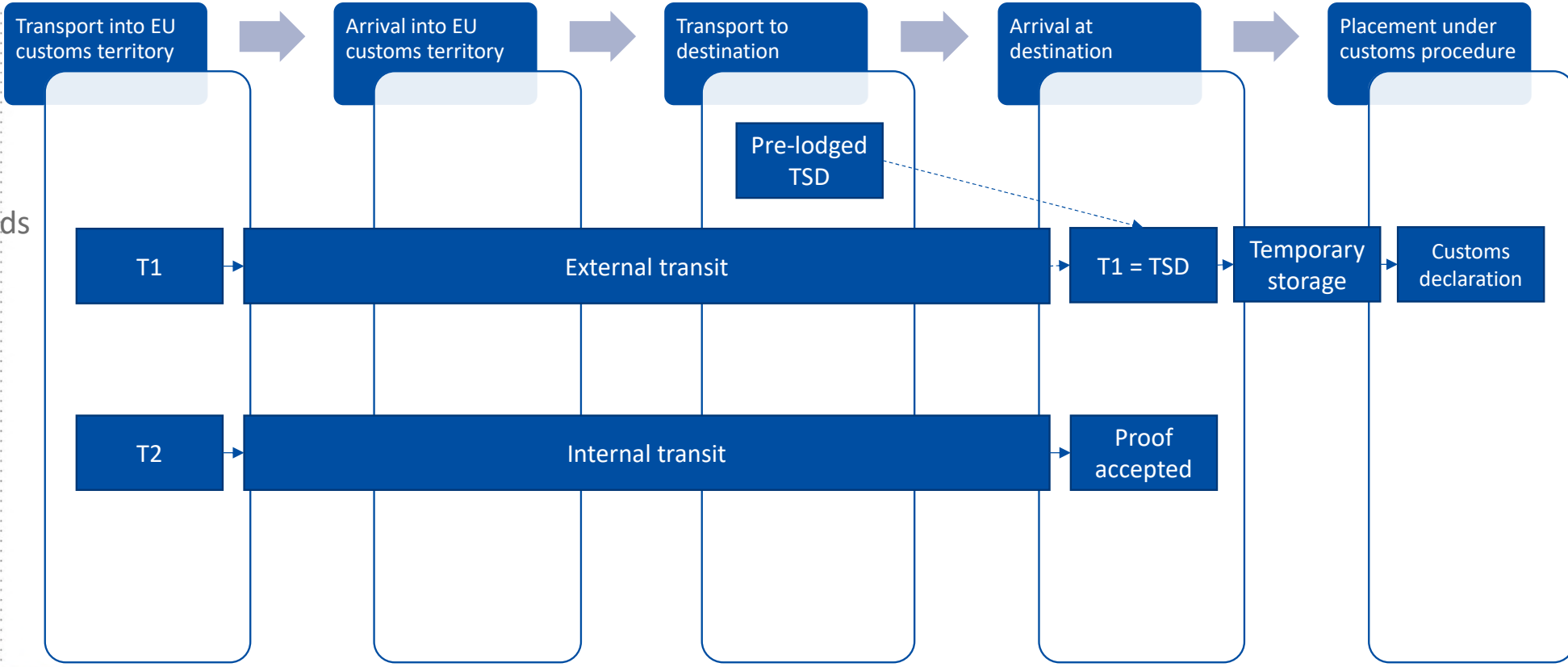

7. MESSAGE STRUCTURE: TSD FOR CONSOLIDATED GOODS

The screenshot shows the 'TEMPORARY STORAGE DECLARATION' form on the website www.fin.belgium.be. The form is titled 'Step 2: General information' and includes a sidebar with navigation options: Declaration information, Master consignment (selected), General information, Parties, Item 1, and ITEM. The main form area contains several sections:

- Transport document:** A dropdown menu set to 'N704 - Master bill of lading' and a text input field for the 'Reference number' (Maximum 20 characters).
- Weight:** A text input field for 'Total gross mass' with a note '*Value greater than 0'.
- Previous document:** A checked checkbox, a dropdown menu set to 'N355 - Entry Summary De...', and a text input field for the 'Reference number' (Maximum 20 characters).
- Reference number UCR:** An unchecked checkbox.
- Transport equipment:** A checked checkbox, followed by a 'CONTAINER 1' section with:
 - 'Identification number*' (Maximum 11 characters, e.g., ZZZ29999999)
 - 'Container packed status*' (dropdown menu)
 - 'Number of seals' (Maximum 10 characters)
 - 'Seal identifier' (Maximum 20 characters)
- Other options:** Unchecked checkboxes for 'Receptacles', 'Supporting documents', 'Additional information', and 'Additional supply chain actor'.

At the bottom of the form are buttons for 'CANCEL', 'SAVE', 'BACK', and 'NEXT'.

- Declaration layer (1x)
 - Main economic operators, declaration identification
- Master consignment layer (1x)
 - Documents, involved parties, weight
- Master consignment Item (9999x)
 - Information specific for each separately identifiable item from the master transport document (weight, packaging, goods description / tariff code, ...)

7. MESSAGE STRUCTURE: TSD FOR DECONSOLIDATED GOODS

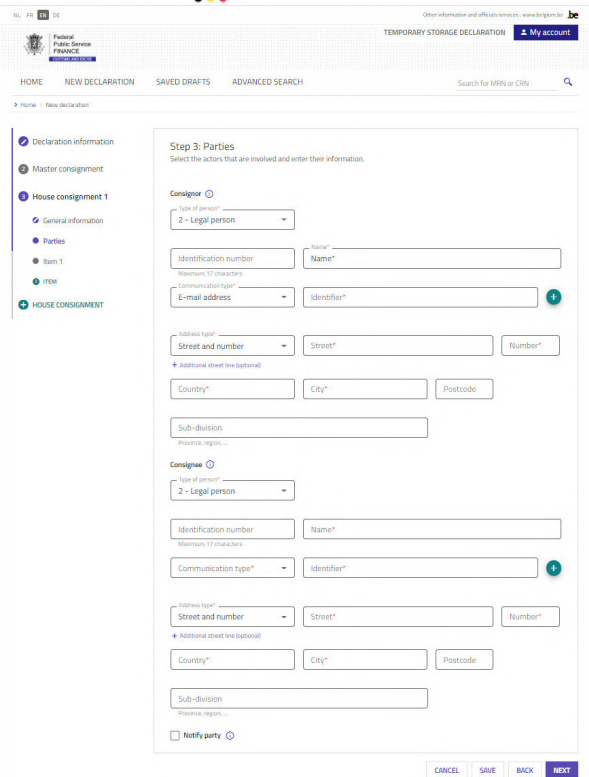

Other information and official services: www.fgov.be

TEMPORARY STORAGE DECLARATION **2. My account**

HOME NEW DECLARATION SAVED DRAFTS ADVANCED SEARCH Search for MRN or CRN

Home / New declaration

Step 3: Parties
Select the actors that are involved and enter their information.

Consignor 

Type of person*
2 - Legal person

Identification number Name*
Maximum 37 characters

Communication type* Identifier* 

E-mail address

Address type*
Street and number Street* Number*
Additional street line (optional)

Country* City* Postcode

Sub-division
Province, region, ...

Consignee 

Type of person*
2 - Legal person

Identification number Name*
Maximum 37 characters

Communication type* Identifier* 

Address type*
Street and number Street* Number*
Additional street line (optional)

Country* City* Postcode

Sub-division
Province, region, ...

Notify party 

CANCEL SAVE BACK NEXT

- Declaration layer (1x)
 - Main economic operators, declaration identification
- Master consignment layer (1x)
 - Documents, involved parties, weight
- Master consignment Item (9999x, optional)
 - Information specific for each separately identifiable item from the master transport document (weight, packaging, goods description / tariff code, ...)
- House consignment layer (99999x)
 - Documents, involved parties, weight
- House consignment Item (9999x)
 - Information specific for each separately identifiable item from the house transport document (weight, packaging, goods description / tariff code, ...)

7. MESSAGE STRUCTURE: TSD FOR NON-CONSOLIDATED GOODS

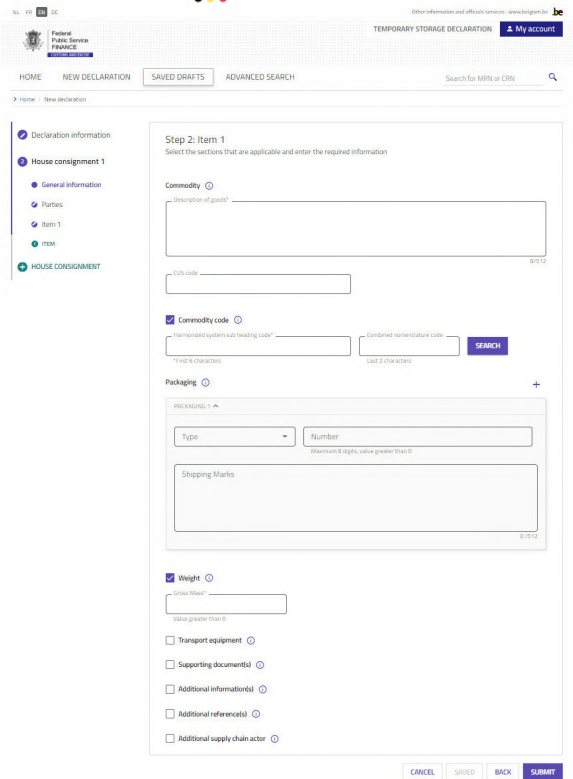

The screenshot shows the 'TEMPORARY STORAGE DECLARATION' form in the 'HOUSE CONSIGNMENT' section. The form is titled 'Step 2: Item 1' and includes the following fields and options:

- Commodity**: A text input field for 'Description of goods'.
- EUS code**: A text input field.
- Commodity code**: A checked checkbox, with two input fields for 'Nomenclature system/sub-heading code' and 'Combined nomenclature code', and a 'SEARCH' button.
- Packaging**: A section with a 'Type' dropdown, a 'Number' input field, and a 'Shipping Marks' text area.
- Weight**: A checked checkbox, with a 'Gross weight' input field.
- Other options**: Unchecked checkboxes for 'Transport equipment', 'Supporting documents', 'Additional information', 'Additional references', and 'Additional supply chain actor'.

Buttons at the bottom include 'CANCEL', 'SAVED', 'BACK', and 'SUBMIT'.

- Declaration layer (1x)
 - Main economic operators, declaration identification
- House consignment layer (99999x)
 - Documents, involved parties, weight
- House consignment Item (9999x)
 - Information specific for each separately identifiable item from the house transport document (weight, packaging, goods description / tariff code, ...)



7. MESSAGE STRUCTURE: TSD WITH ENS RE-USE

Other information and official services: www.belgium.be

TEMPORARY STORAGE DECLARATION My account

HOME NEW DECLARATION SAVED DRAFTS ADVANCED SEARCH Search for MRN or CRN

Home / New declaration

Declaration information
Master consignment

Step 2: Master consignment

Transport document ⓘ

Type* N741 - Master airwaybill Reference number*
*Maximum 70 characters

Previous document ⓘ

Type* Reference number*
*Maximum 70 characters

Goods item identifier (optional)

CANCEL SAVE BACK SUBMIT

ALL ENS HOUSE CONSIGNMENTS

- Declaration layer (1x)
 - Main economic operators, declaration identification
- Master consignment layer (1x)
 - Transport document

Other information and official services: www.belgium.be

TEMPORARY STORAGE DECLARATION My account

HOME NEW DECLARATION SAVED DRAFTS ADVANCED SEARCH Search for MRN or CRN

Home / New declaration

Declaration information
House consignment 1
House consignment 2
HOUSE CONSIGNMENT

Step 3: House consignment HOUSE CONSIGNMENT 2

Transport document ⓘ

Type* Reference number*
*Maximum 70 characters

Previous document ⓘ

Type* Reference number*
*Maximum 70 characters

Goods item identifier (optional)

CANCEL SAVE BACK SUBMIT

SPECIFIC ENS HOUSE CONSIGNMENTS

- Declaration layer (1x)
 - Main economic operators, declaration identification
- Master consignment layer (1x, optional)
 - Transport document
- House consignment layer (99999x)
 - Transport document



MIG v0.1.0

8. PRE-LODGED MESSAGE FLOW

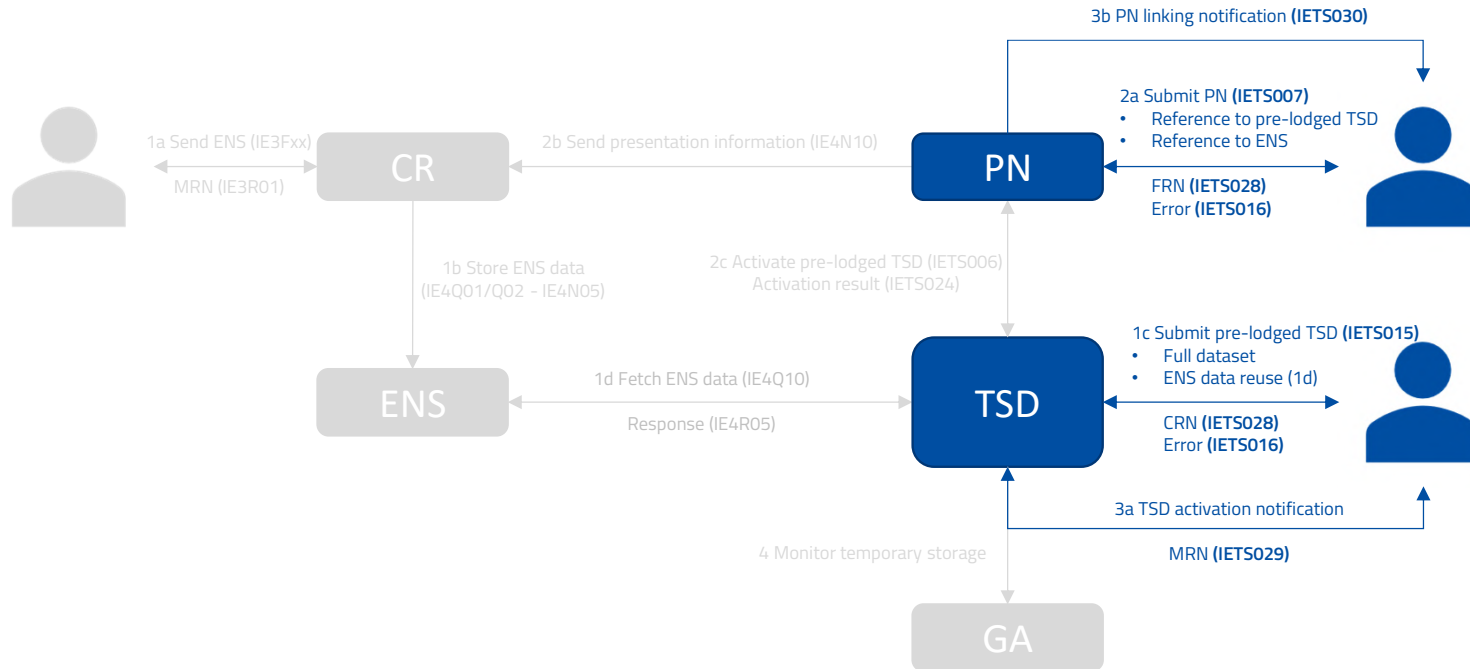

PN = Presentation notification component
 TSD = Temporary storage declaration component
 GA = Goods accounting component
 ENS = Entry summary declaration data source
 CR = ENS Common Repository



MIG v0.1.0

8. COMBINED MESSAGE FLOW

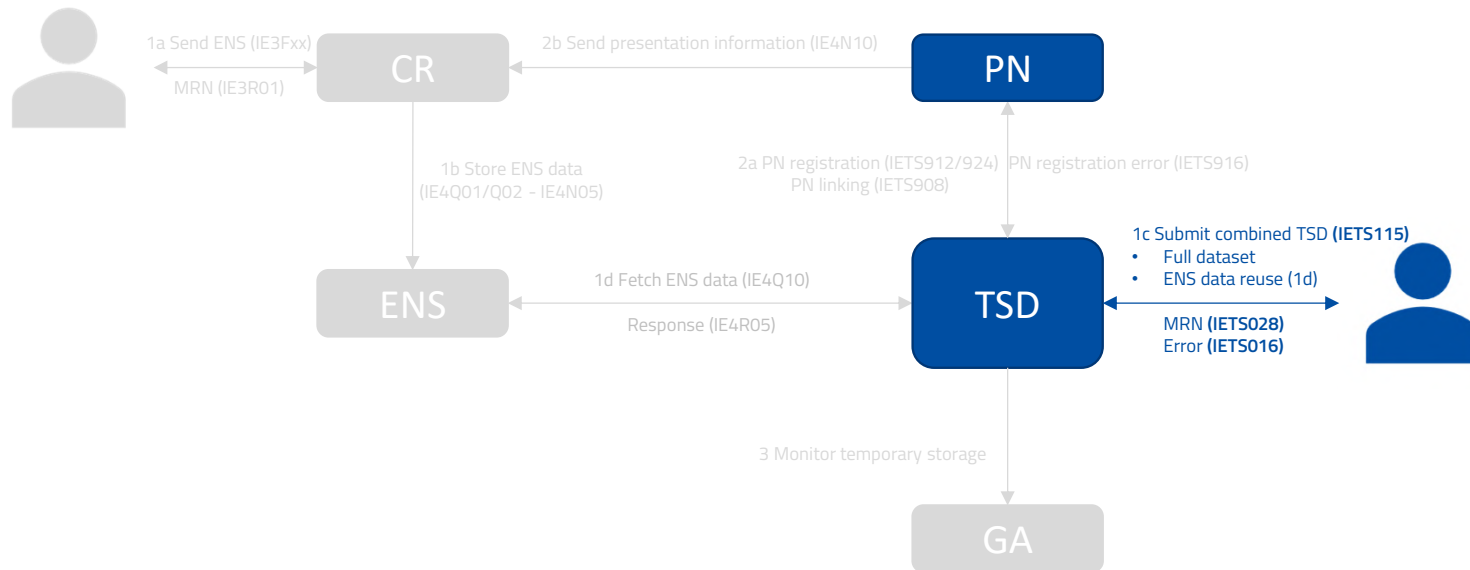

PN = Presentation notification component
 TSD = Temporary storage declaration component
 GA = Goods accounting component
 ENS = Entry summary declaration data source
 CR = ENS Common Repository



8. AMENDMENT MESSAGE FLOW

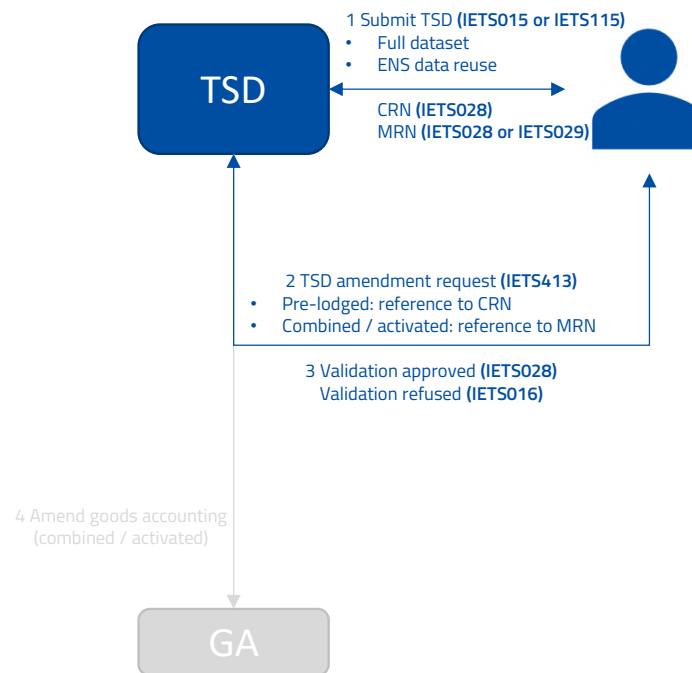

PN = Presentation notification component
TSD = Temporary storage declaration component
GA = Goods accounting component
ENS = Entry summary declaration data source
CR = ENS Common Repository



8. INVALIDATION MESSAGE FLOW

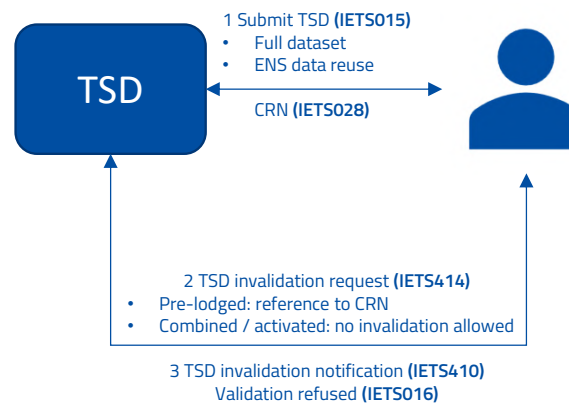

PN = Presentation notification component
TSD = Temporary storage declaration component
GA = Goods accounting component
ENS = Entry summary declaration data source
CR = ENS Common Repository



Federal
Public Service
FINANCE

NCTS PHASE 5



WWW.FIN.BELGIUM.BE

CUSTOMS AND EXCISES • FEDERAL PUBLIC SERVICE FINANCE



NCTS (NEW COMPUTERISED TRANSIT SYSTEM)

- **NCTS**
is the application that manages the transit declarations, this on the basis of electronic message exchange. This exchange of messages is between different parties:
 - Between economic operators and customs (external domain)
 - Between customs offices of 1 country (national domain)
 - Between customs offices of different countries (common domain)
- **Union transit :**
 - **External transit: T1**
External transit makes it possible to transfer non-union goods from one place inside the customs territory of the union with suspension of customs duties and other taxes, such as VAT and excise duties
 - **Internal transit: T2**
With the procedure internal transit an economic operator can temporary leave the customs territory of the Union and come back while maintaining the Union status of the goods.
- **Common transit:**
 - Transit between the customs territory of the Union and the other contracting transit countries and also transit between other parties of the contracting transit countries.
 - The Contracting Transit countries (CTC) are: the European Union, Iceland, Switzerland, Liechtenstein, Norway, United Kingdom, Turkey, the former Yugoslav republic of Macedonia and Serbia,



PHASE 4 TO PHASE 5 – IMPACT ON BUSINESS PROCESSES

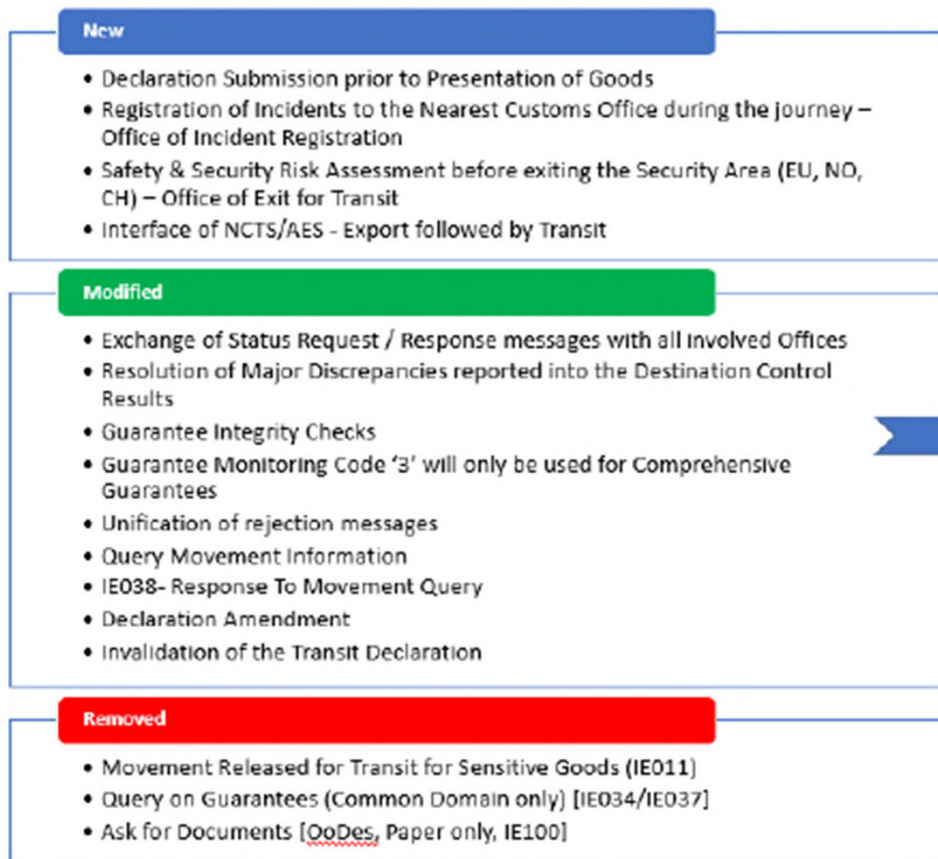

Office Role	Impact
Office of Departure (until movement release)	Major
Office of Departure (after movement release)	Minor
Office of Departure (recovery states)	Minor
Office of Destination (without Recovery States)	Minor
Office of Exit for Transit	New
Office of Incident Registration	New



NCTS P5 ACTORS

Role Type	Role Name	Organization
OoDep	Customs Office of Departure	Customs Office
OoGua	Customs Office of Guarantee	Customs Office
<u>OoExtTra</u>	Customs Office of Exit for Transit	Customs Office
OoTra	Customs Office of Transit	Customs Office
OoDes	Customs Office of Destination	Customs Office
<u>OoIncReg</u>	Customs Office of Incident Registration	Customs Office
Holder	Holder of the Transit Procedure	Trader
TraDes	Trader at Destination	Trader



INTERACTION WITH NEW SYSTEMS

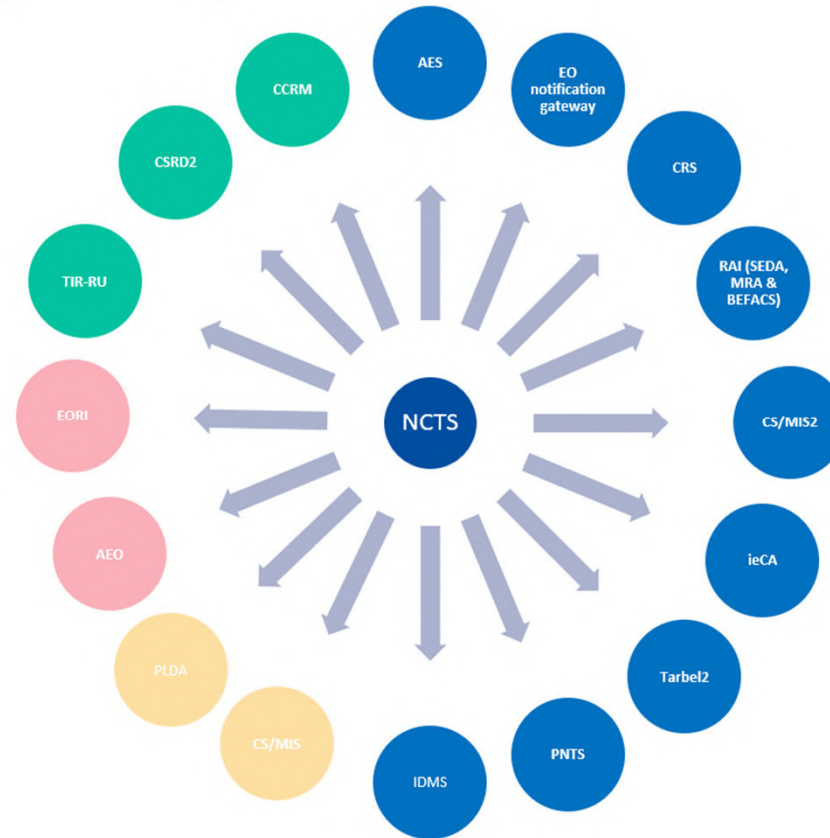



MODIFICATIONS DATA STRUCTURE ANNEX B

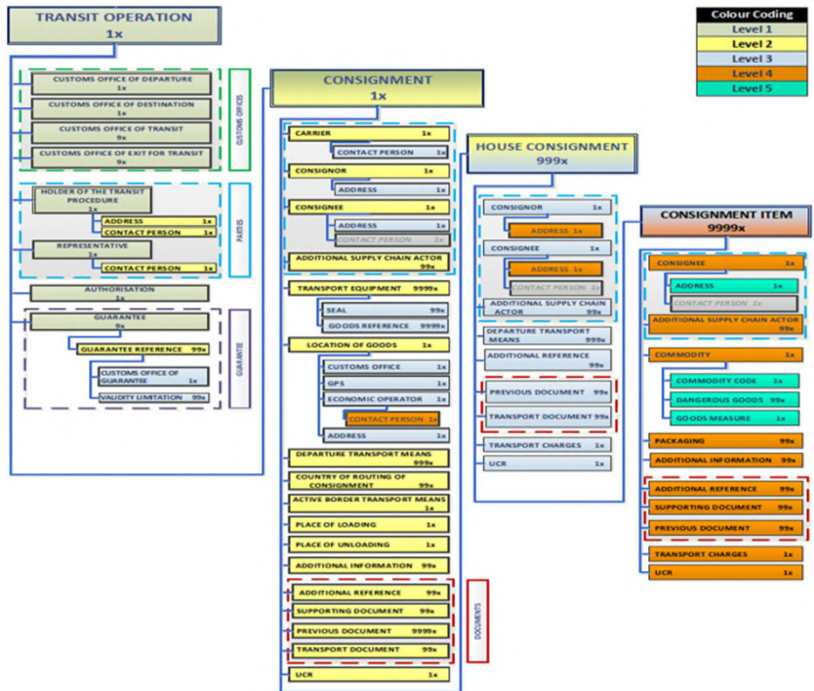

NL FR DE

Federal Public Service FINANCE

NEW COMPUTERISED TRANSIT SYSTEM [My account](#)

HOME NEW DECLARATION TEMPLATES SAVED DRAFTS Search for MRN

Home New declaration

Step 3: General information HOUSE CONSIGNMENT 1

Select the sections that are applicable and enter the required information.

Weight

Gross mass*

*Maximum 16 digits with 6 digits after decimal

Reference number UCR

Reference number UCR
Maximum 35 characters

Involved countries

Country of dispatch

Departure transport mean(s)

DEPARTURE TRANSPORT MEAN 1

Nationality

Type of identification Identification number

Maximum 35 characters



IMPACT OF THE MESSAGES FROM NCTS P4 TO NCTS P5

- **Messages:**
- New: 18
- Deleted: 11
- Modified: 67
- Replaced: 12
- Unchanged: 4

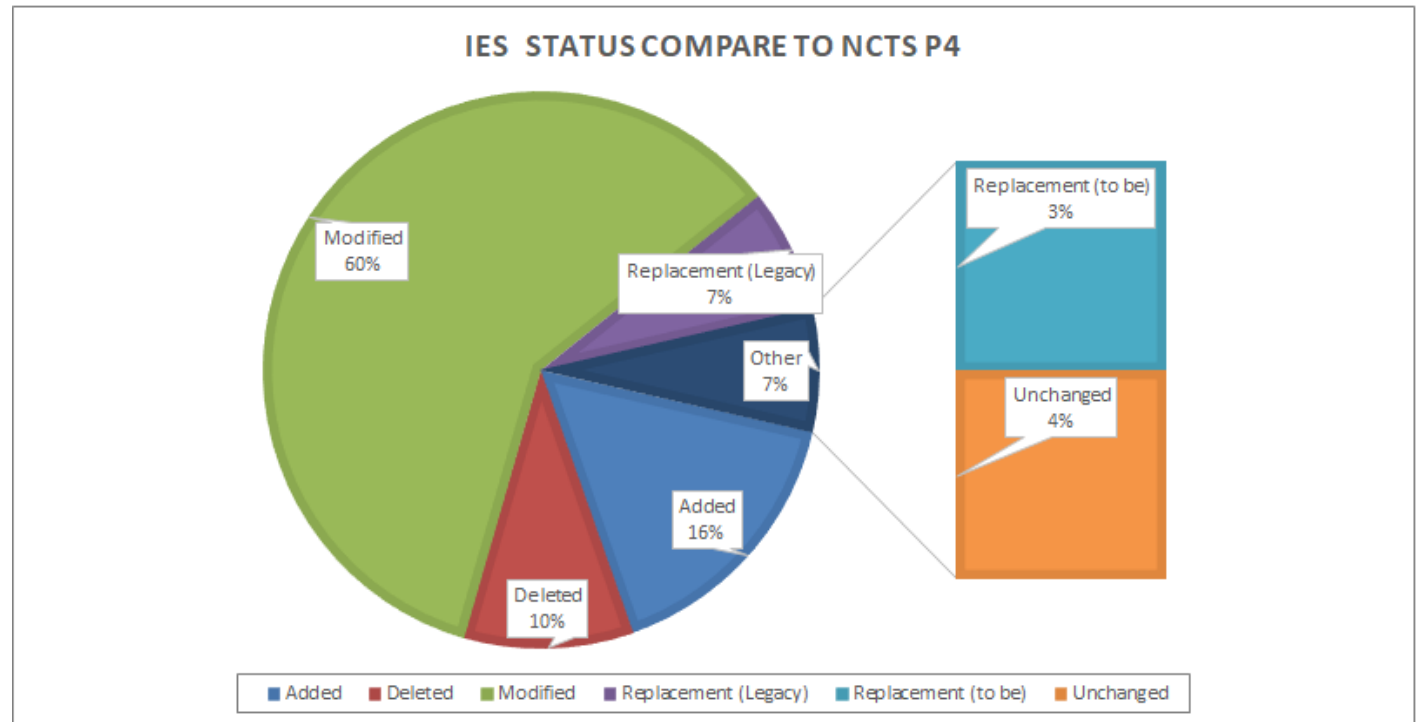



UNIFICATION OF REJECTION MESSAGES

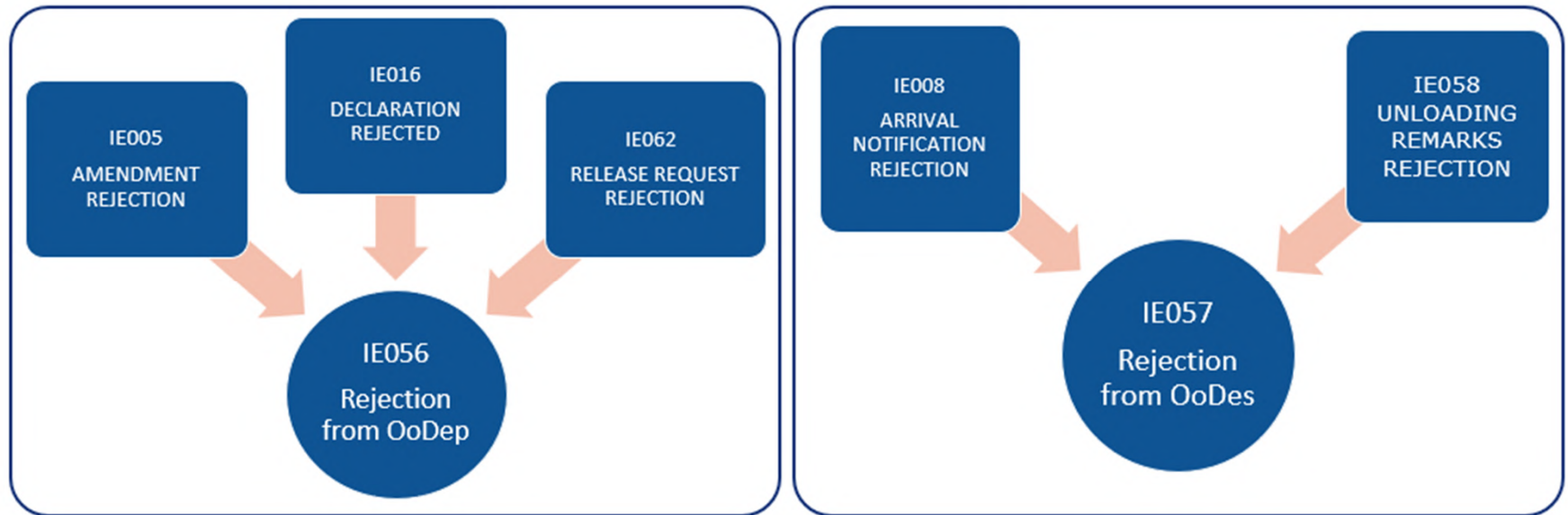



NEW PROCESSES

- The following new processes are **implemented** NCTS-P5:
 - Declaration Submission prior to Presentation of Goods
 - Registration of Incidents to the Nearest Customs Office during the course of the journey – Office of Incident Registration
 - Safety & Security Risk Assessment before exiting the Security Area (EU, NO, CH) – Office of Exit for Transit
 - Interface of NCTS/AES - Export followed by Transit



DECLARATION SUBMISSION PRIOR TO PRESENTATION OF GOODS

- The customs declaration can be lodged for the purpose of risk analysis thirty (30) days prior to the presentation of the goods to the Office of Departure (i.e. the value of the 'Additional Declaration Type' is equal to "D" in the 'Declaration Data' E_DEC_DAT (IE015) message).

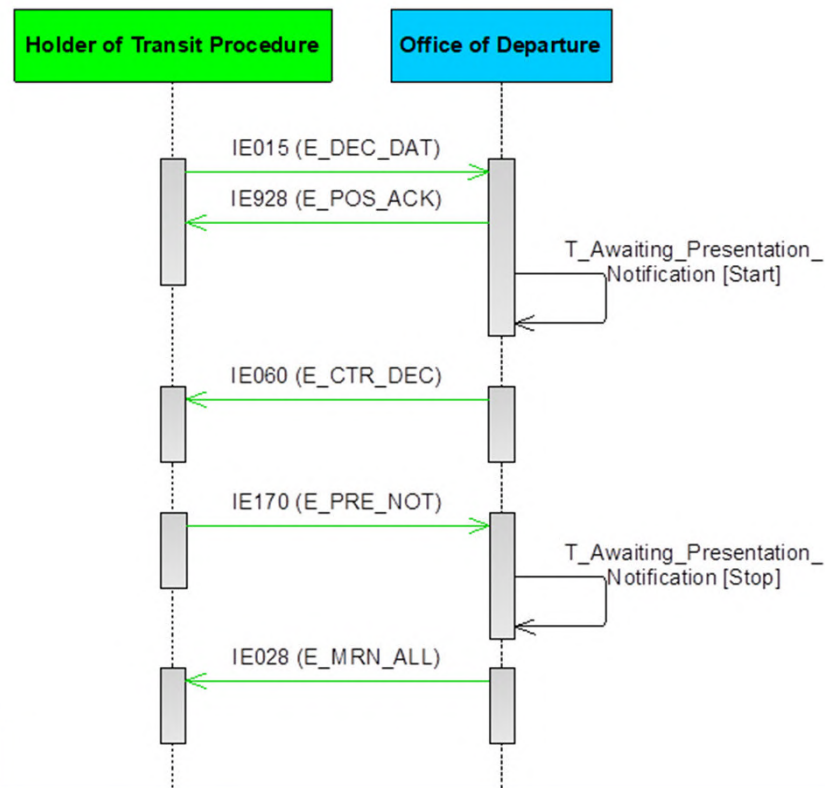



NEW OFFICE ROLE: OFFICE OF INCIDENT REGISTRATION

During the movement of goods under the Union or common transit procedure, incidents En-Route can happen:

- the carrier is obliged to deviate from the prescribed itinerary due to circumstances beyond their control;
- seals are broken or tampered during transportation for reasons beyond the carrier's control;
- goods are transferred from one means of transport to another;
- imminent danger necessitates immediate partial or total unloading of the sealed means of transport;
- an event occurs which may affect the ability of the Holder of the Transit Procedure or the carrier to comply with their obligations;
- etc.

Without any undue delay after the incident, the carrier presents the goods together with the MRN of the transit declaration to the nearest customs Office of the National Administration in whose territory the means of transport is located at that time. This customs Office is named the Office of Incident Registration.





REGISTRATION OF INCIDENTS TO THE NEAREST CUSTOMS OFFICE DURING THE COURSE OF THE JOURNEY – OFFICE OF INCIDENT REGISTRATION

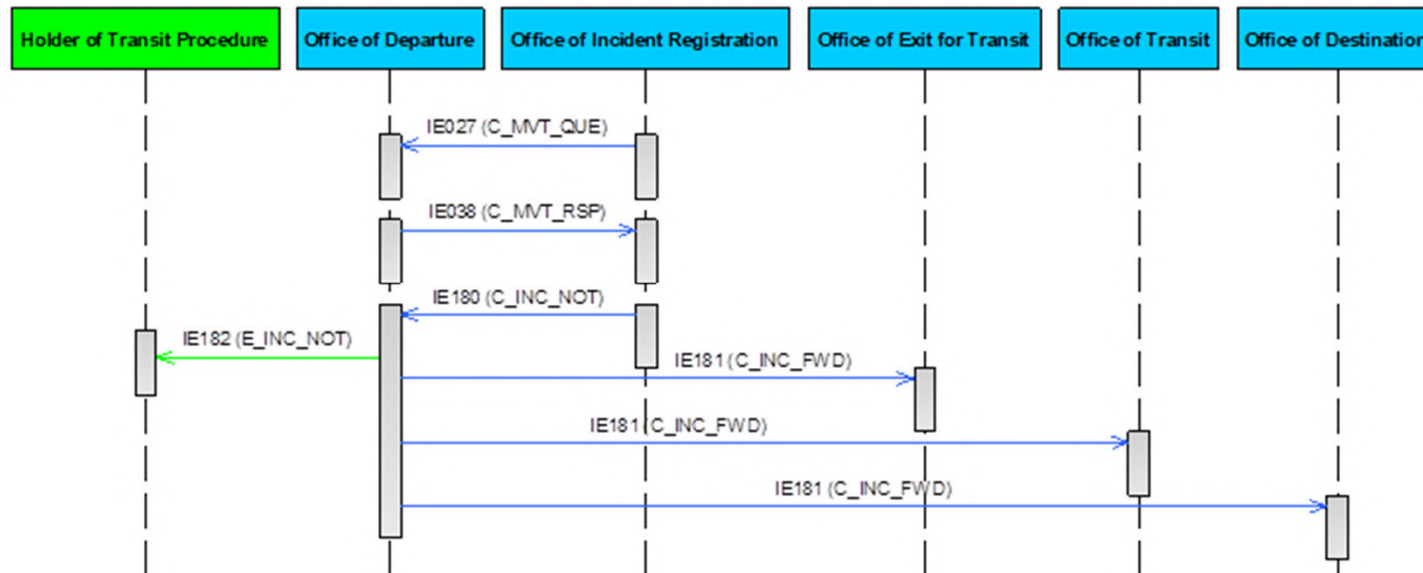



NEW OFFICE ROLE: OFFICE OF EXIT FOR TRANSIT

- Security Area = EU + Switzerland and Norway
- Non-union goods leaving safety and security area to a CTC country other than Norway or Switzerland, for example: Goods from Belgium to Ireland via United Kingdom

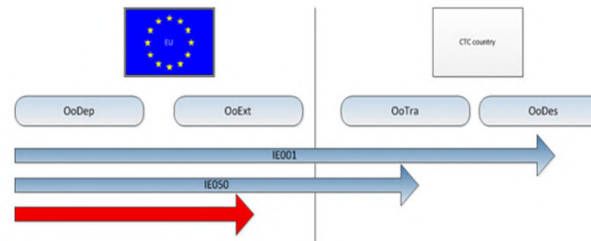

- If the transit declaration is also used for the purpose of safety and security, the Office of Departure notifies the Office of Exit for Transit with the 'Anticipated Exit For Transit Record' C_AXR_SND (IE160) message containing the transit declaration data along with EXS particulars, and risk analysis results (i.e. risk results are sent only when the Office of Departure belongs to the Security Area).



SAFETY & SECURITY RISK ASSESSMENT BEFORE EXITING THE SECURITY AREA (EU, NO, CH) – OFFICE OF EXIT FOR TRANSIT

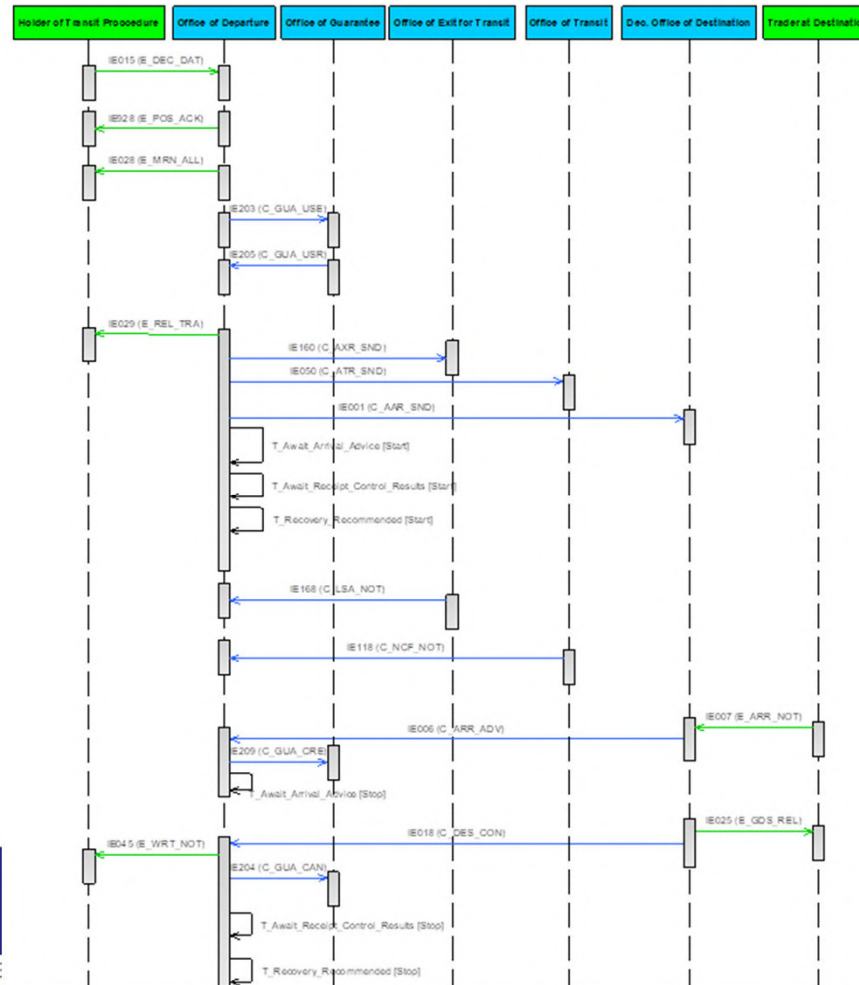



INTERFACE OF NCTS/AES - EXPORT FOLLOWED BY TRANSIT – PART 1

- There are cases when transit has export as previous procedure. In that case, NCTS needs to interface with AES:
 - When the goods are released for export and then the external transit procedure follows, the customs Office of exit shall be the customs Office of departure of the transit operation (UCC IA Article 329);
 - In case of internal transit, the customs Office of exit shall be the customs Office of departure and the Office of Destination is situated either:
 - in a common transit country (UCC IA Article 329), or
 - at the border of the customs territory of the Union and the goods are taken out of that customs territory, after having passed through a country or territory outside the customs territory of Union (UCC IA Article 329).



INTERFACE OF NCTS/AES - EXPORT FOLLOWED BY TRANSIT – PART 2

- When external transit follows export, NCTS notifies AES with the 'Destination Control Results to AES' N_DES_CON (IE042) message at the time the movement is released for transit. When AES receives this message, the exit control results are directly communicated to the Office of Export with the 'Exit Results' C_EXT_RES (IE518) message and that finalizes the export movement. However, even though any further interaction with AES is finished, the transit procedure continues until the 'Destination Control Results' C_DES_CON (IE018) message is sent to the Office of Departure from the Office of Destination.

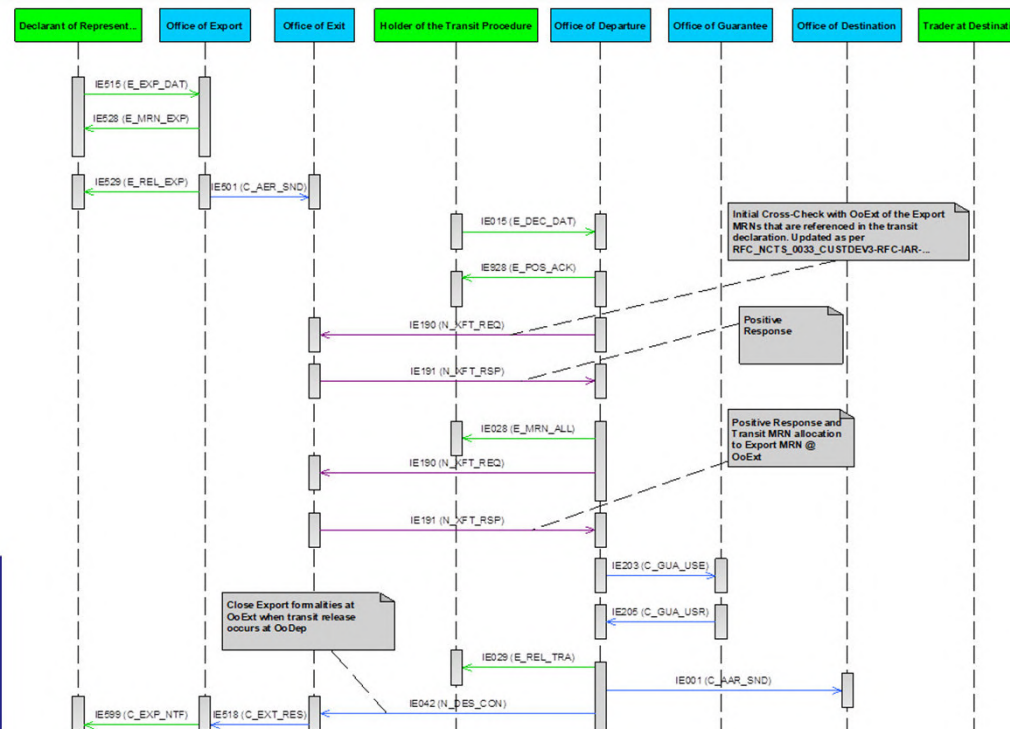



PHASED OUT PROCESSES

- Movement Released for Transit for Sensitive Goods (IE011)
- Ask for Documents [OoDes, Paper only, IE100]
- Query on guarantees IE034-IE037 removed for common domain only

MESSAGE IMPLEMENTATION GUIDE FINAL

- Information can change once a year (change release management from European Commission) [NCTS P5 | FOD Financiën \(belgium.be\)](#)
- Last updates published on 05/11/2021
- Minor national changes can be published more often (like implementation of a national rule)

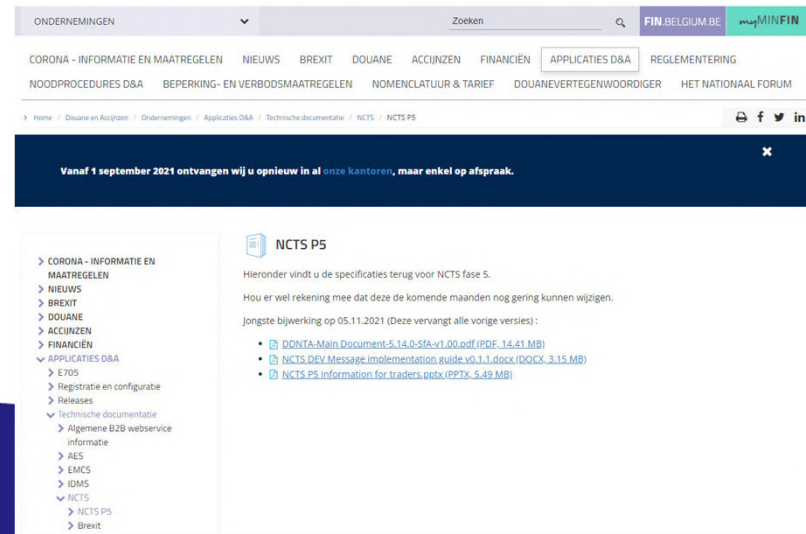

The screenshot shows the website www.fin.belgium.be. The top navigation bar includes 'ONDERNEMINGEN', 'Zoeken', and 'FIN BELGIUM BE myMINFIN'. Below this is a menu with categories like 'CORONA - INFORMATIE EN MAATREGELEN', 'NIEUWS', 'BREXIT', 'DOUANE', 'ACCIJNZEN', 'FINANCIËN', 'APPLICATIES D&A', and 'REGLEMENTERING'. A dark blue banner at the top of the main content area reads: 'Vanaf 1 september 2021 ontvangen wij u opnieuw in al onze kantoren, maar enkel op afspraak.' The main content area features a sidebar with a tree view of categories, including 'CORONA - INFORMATIE EN MAATREGELEN', 'NIEUWS', 'BREXIT', 'DOUANE', 'ACCIJNZEN', 'FINANCIËN', 'APPLICATIES D&A', 'EYDS', 'Registratie en configuratie', 'Releases', 'Technische documentatie', 'Algemene B2B webservice informatie', 'AES', 'EMCS', 'IDMS', 'NCTS', 'NCTS P5', and 'Brexit'. The main content area is titled 'NCTS P5' and contains the following text: 'Hieronder vindt u de specificaties terug voor NCTS fase 5. Hou er wel rekening mee dat deze de komende maanden nog gering kunnen wijzigen. Jongste bijwerking op 05.11.2021 (Deze vervangt alle vorige versies):' followed by a list of links: 'DONTA-Main Document-5.14.0-Sfa-v1.00.pdf (PDF, 14.41 MB)', 'NCTS DEV Message Implementation guide v0.1.1.docx (DOCX, 3.15 MB)', and 'NCTS P5 Information for traders.pptx (PPTX, 5.49 MB)'.



CONTENT OF MIG

- EO Notification Gateway description
- Process model graphics
- Information model (messages)
- Information model description (explanation on content of messages)
- Datamapping NCTS P4 vs P5
- Rules and conditions
- Codelists
- XML mapping
- XSD
- Rules mapping



TRANSITIE PERIOD – PARALLEL RUN

Fase 4



Transitie



Only for open
movements phase
4

Fase 5



From start of TP
use of NCTS P5 for
new movements



NEXT STEPS

- Start your analysis based on the documents on our site: [NCTS P5 | FOD Financiën \(belgium.be\)](#)
- Go live date: Q1 2023
- Testing: will be available soon and communicated on our site and, you can also subscribe to mailbox from helpdesk to be informed when testing will be possible (to subscribe send an email to ncts.helpdesk@minfin.fed.be)



Federale
Overheidsdienst
FINANCIËN

IMPORT DECLARATION MANAGEMENT SYSTEM (IDMS) CENTRALISED CLEARANCE FOR IMPORT



WWW.FIN.BELGIUM.BE

DOUANE EN ACCIJNZEN • FEDERALE OVERHEIDSDIENST FINANCIËN

.be

IDMS

- IDMS : import declarations Management System
- Replaces PLDA Import
- Will be added to IDMS H7 (in prod since 1/7/2022)
- Base for Centralised clearance for Import
- E-globalisation out of scope

- 2 ways to lodge a declaration

- New Webinterface

The screenshot shows the 'GEAVANCEERD ZOEKEN' (Advanced Search) page in the IDMS system. The page header includes the logo of the 'Federale Overheidsdienst FINANCIEN' and the text 'SYSTEEM VOOR HET BEHEER VAN INVOERAANGIFTEN'. A navigation bar contains 'HOME', 'GEAVANCEERD ZOEKEN', and a search bar with 'MRN' selected and 'Zoek op MRN'. Below the navigation bar, the page title 'GEAVANCEERD ZOEKEN' is displayed. The main content area is divided into two sections: 'Aangifte informatie' (Declaration information) and 'Status' (Status). The 'Aangifte informatie' section contains a date range input field labeled 'Acceptance date range*' with a note '*Maximale periode van 2 maanden', and two text input fields: 'EORI aangever' (with a note 'Maximum 17 karakters') and 'Aangever naam' (with a note 'Read only'). The 'Status' section contains four checkboxes: 'Aanvaard', 'In afwachting van risico analyse', 'Onder controle', and 'Goederen niet vrijgegeven'.

- B2G – component (new messages)

MESSAGE EXCHANGES

- IDMS
- IE415: Declaration
- IE456: Rejection declaration
- IE428: Acceptance declaration
- IE460: Control decision notification
- IE429: Release for Import
- IE451: No release

PLDA

SadImport

SadResponse

SadResponse

-

SadImportRelease

-

MESSAGE STRUCTURE

- Declaration layer (1x)
 - Involved customs offices and main economic operators, exchange rate, declaration identification
- Shipment layer (1x)
 - Documents, involved supporting parties,
- Goods Item (9999x)
 - Information specific for a single goods item

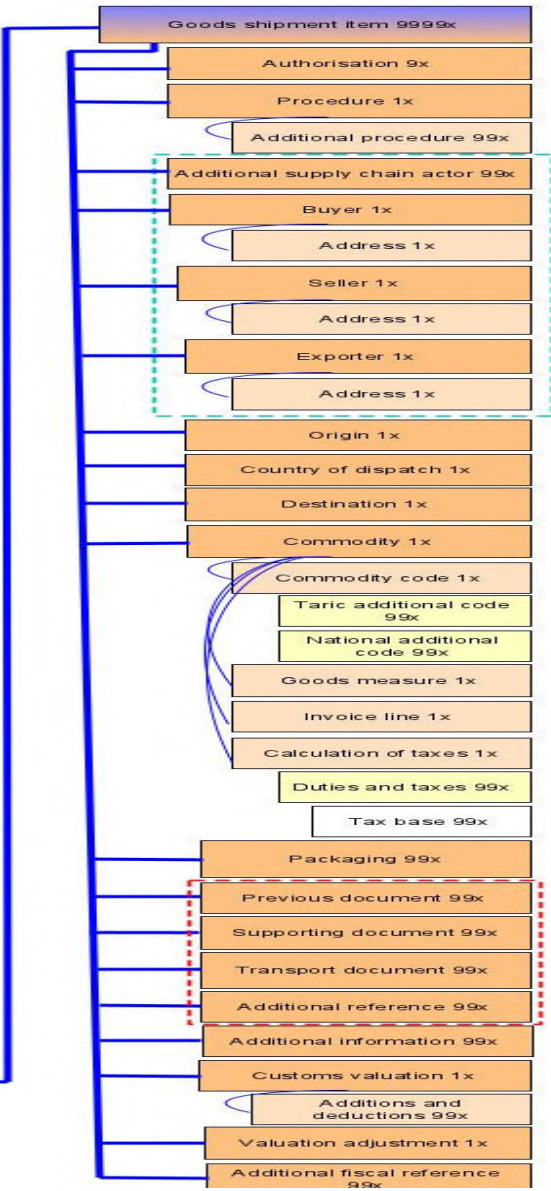
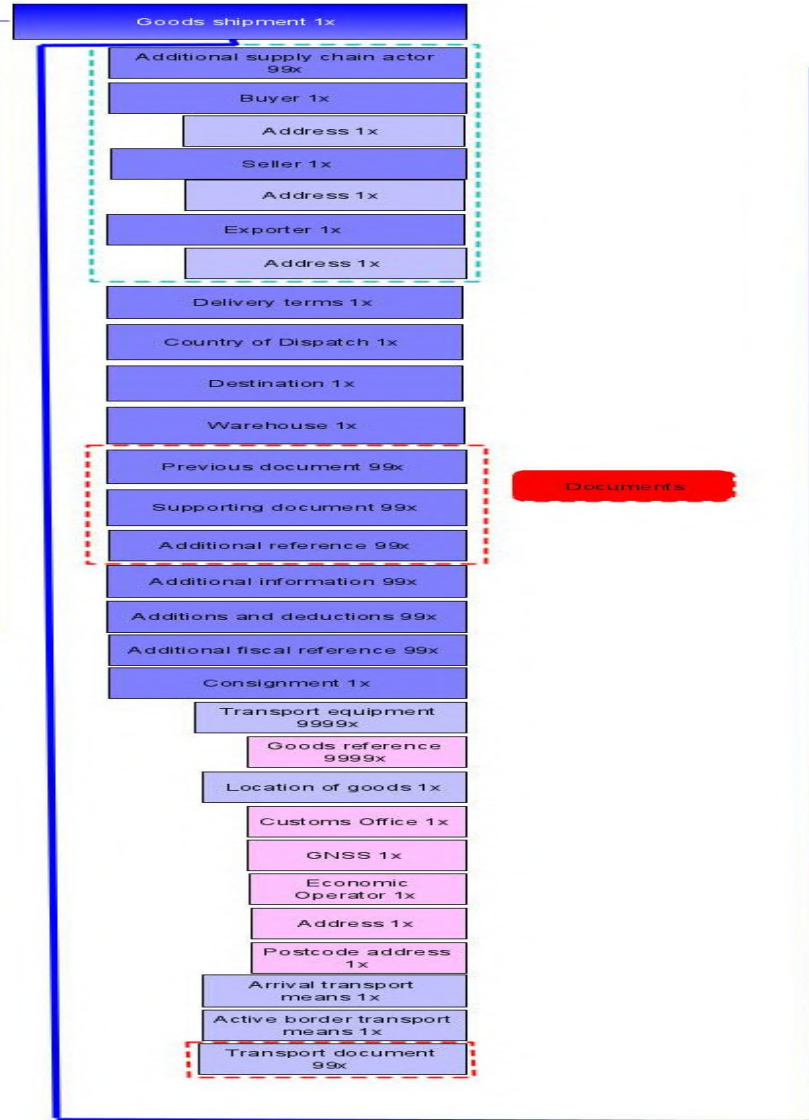
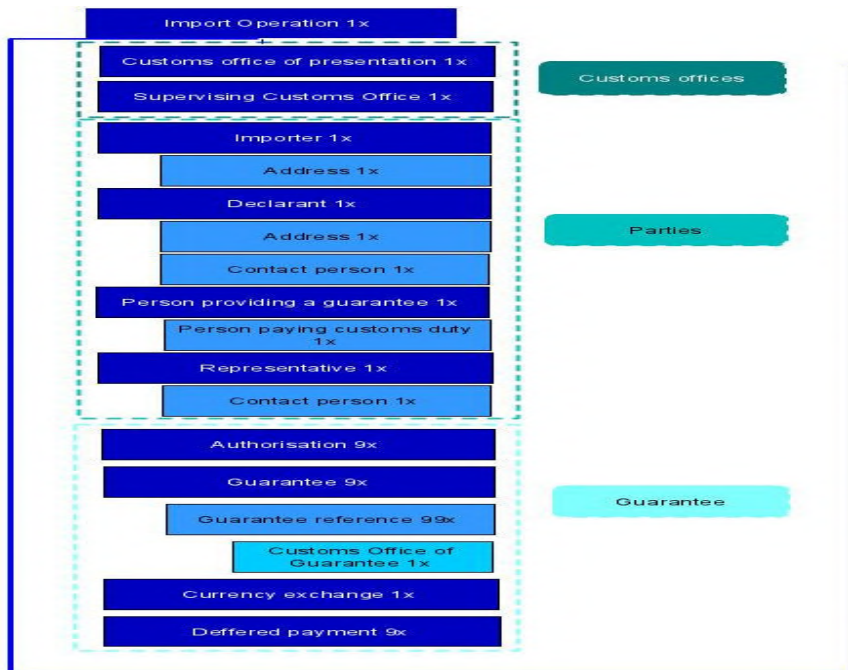

DIFFERENT DATASETS ANNEX B

- H1 : Declaration for release for free circulation and Special procedure — specific use — declaration for end-use
- H2 : Special procedure — storage — declaration for customs warehousing
- H3 : Special procedure — specific use — declaration for temporary admission
- H4 : Special procedure — processing — declaration for inward processing
- H5 : Declaration for the introduction of goods in the context of trade with special fiscal territories
- H6 : Customs declaration in postal traffic for release for free circulation
- I1 : Import Simplified declaration
- I2 : Presentation of goods to customs in case of entry in the declarant's records or in the context of customs declarations lodged prior to the presentation of the goods at import

<https://svn.taxud.gefeg.com/svn/Documentation/EUCDM/EN/index.htm>



INTERACTION WITH OTHER SYSTEMS

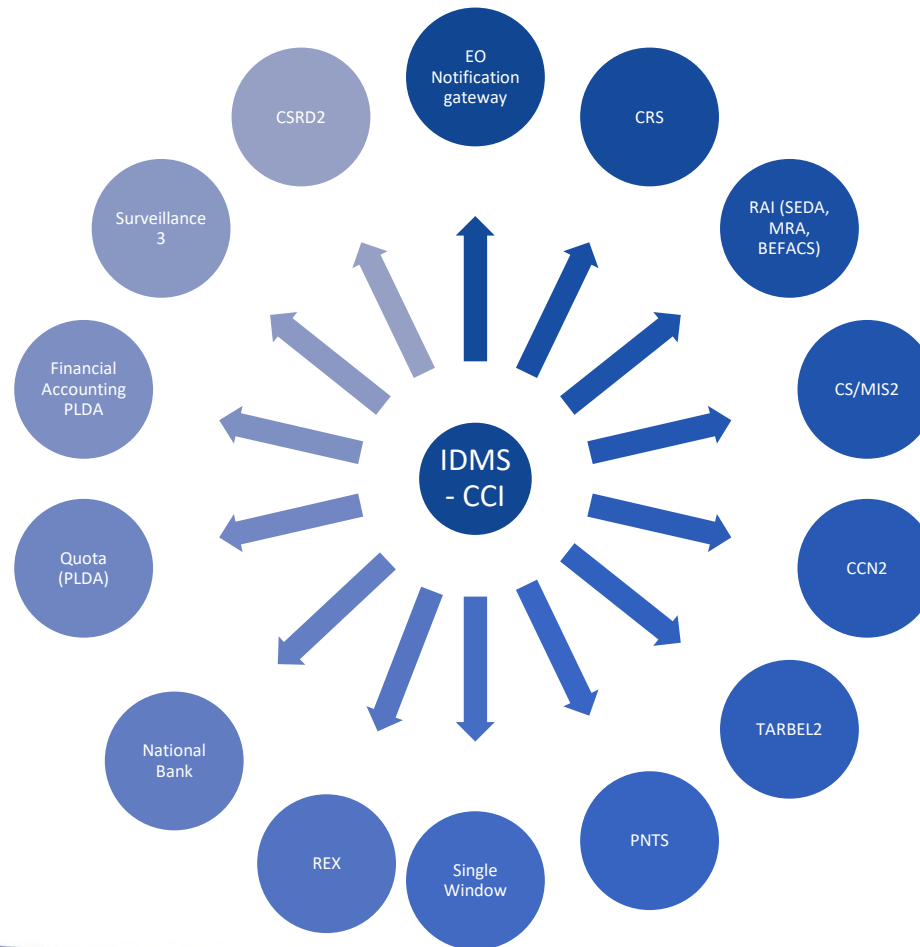

MAJOR DIFFERENCES PLDA - IDMS

- Control Notification
 - Declaration selected for control declarant will be notified.
- Prelodged declarations
 - Risk analysis will already be done at the acceptance of the prelodged declaration
 - AEO-companies will be informed before presentation if there is a control
 - Presentation notification is needed to activate the declaration. No longer after arrival of the ship
- Regularisations / Amendments
 - No regularisations possible in IDMS
 - Only amendments
 - After amendment no new MRN

CENTRALISED CLEARANCE

- Centralised clearance (CC) is one of the simplifications linked with the placement of goods under a customs procedure of the Union Customs Code (UCC).
- It authorises a holder to lodge at the customs office where he is established, a customs declaration for goods which are presented at another customs office within the customs territory of the Union.
- The applicant for the authorisation must be an authorised economic operator for customs simplifications (AEOC).







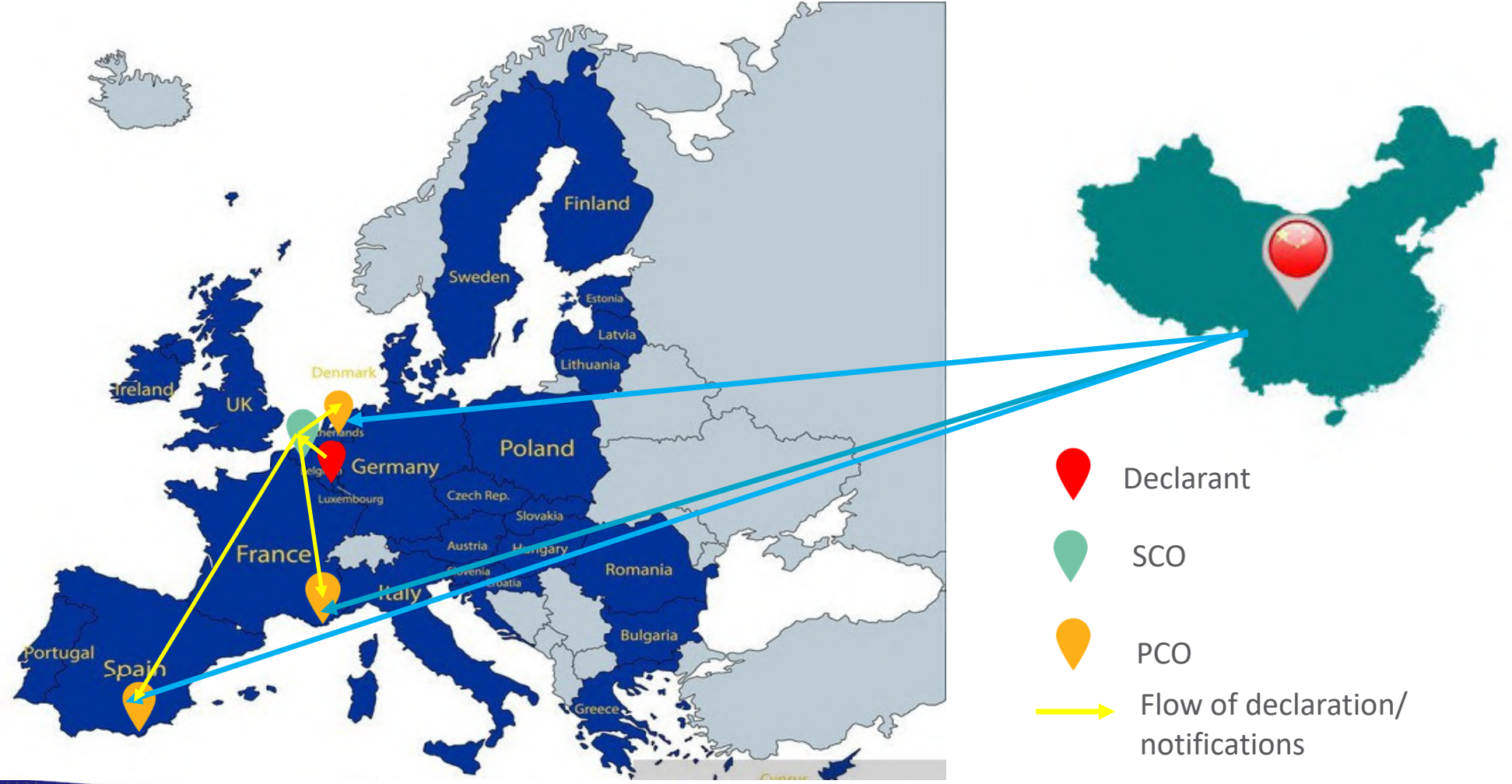

Fed
Ove
FIN

CENTRALISED CLEARANCE CONTEXT



-  Declarant
-  SCO
-  PCO
-  Flow of declaration/notifications
-  Flow of goods

CURRENT AUTHORISATIONS – AS IS

- Unlike other authorisations for simplifications, cross-border authorisations for simplified procedures (SASP) which are still valid on 1 May 2016, shall remain valid until the dates on which the Centralised Clearance for Import (CCI) and AES (Automated Export System) systems, enter into force respectively
- To lodge declarations PLDA is currently used:
 - Box 44: Special entries/documents submitted/certificates and authorisations + Entry code 4011+country code



AS IS PROCESS FOR CROSS BORDER IMPORT CUSTOMS DECLARATIONS

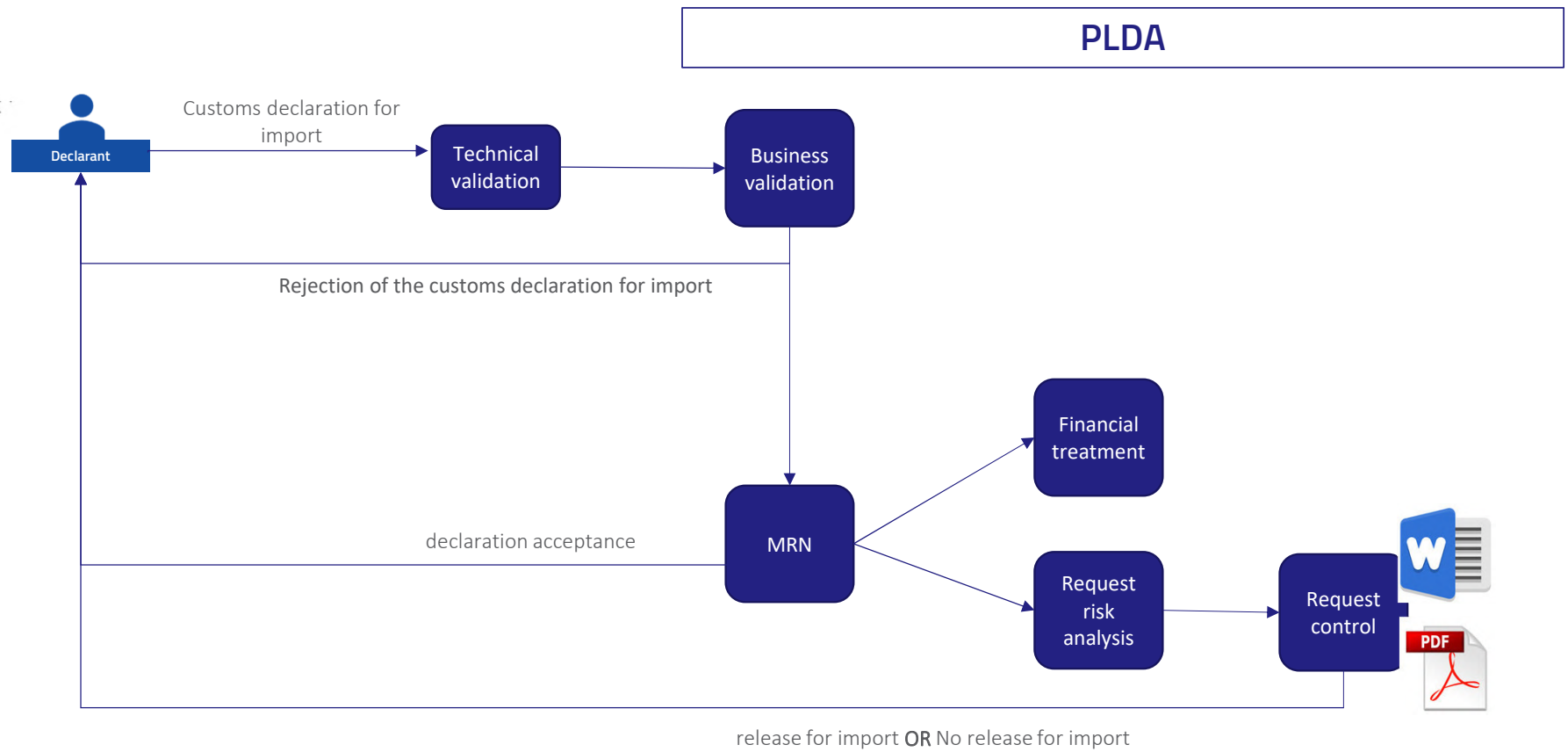



ISSUES WITH THE AS IS WORK FLOW

- No specific data-elements in the customs declaration for CCI
- No harmonised system on EU-level – no uniformity
- No automated communication with the other MS, only through mail



FUTURE PROJECT - SCOPE CCI – IN (PHASE 1)

1. Declaration types

- Standard declaration (A)
- Simplified declaration (C, F)
- supplementary declaration (Y)
- transaction-by-transaction only approach
- Pre-lodged declarations – in advance of presentation (D - 30 days)

2. Procedures

- Release for free circulation (H1)
- Customs warehousing (H2)
- Inward processing (H4)
- Import simplified declaration (I1)
- Presentation of goods to customs in the context of customs declarations lodged prior to the presentation of the goods at import (I2)

SCOPE – OUT (PHASE 1)

1. Excise goods and CAP (Common Agricultural Policy) goods
2. EIDR (entry into the declarants records - Z)
3. Customs Declaration for goods in the context of trade with special fiscal territories (H5)
4. Temporary admission (H3)
5. Transfer of supporting documentation between the SCO and PCO

These subjects will be the scope for phase 2 of CCI.

TO BE – CCI PHASE 1

- Unification of rejection messages
- Double validations by SCO and PCO – CC qualifier
- Submission prior to presentation of goods
- Sending requested documents by message for control purposes



UNIFICATION OF REJECTION MESSAGES

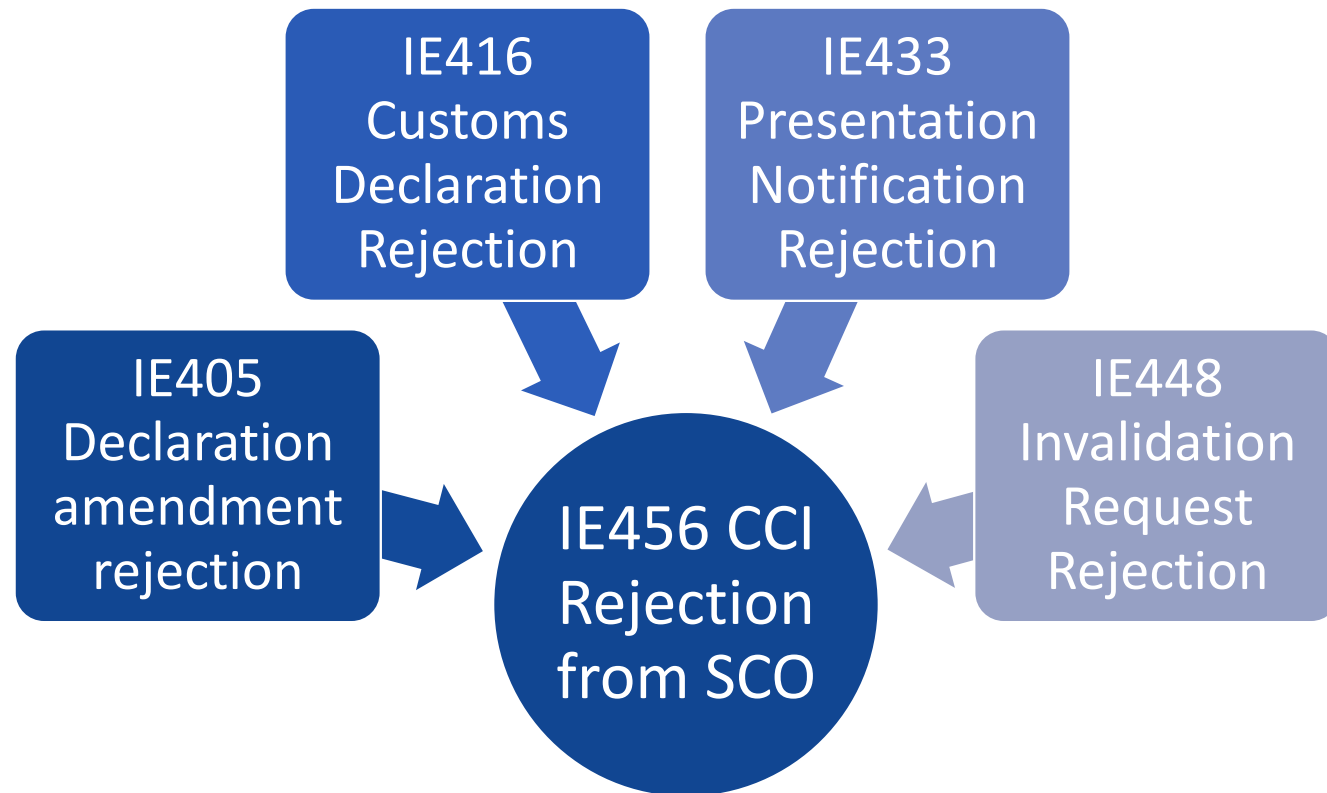

DOUBLE VALIDATIONS BY SCO AND PCO – CC QUALIFIER

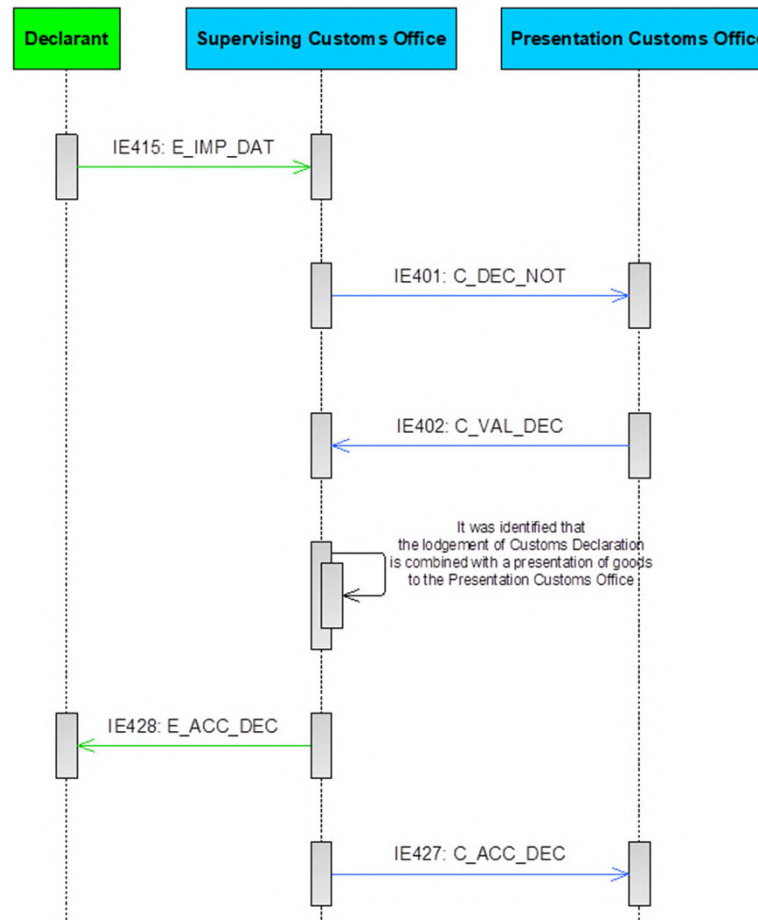



DOUBLE VALIDATIONS BY SCO AND PCO – CC QUALIFIER

Example: ES is the Sender, FR is the Receiver

---PREVIOUS DOCUMENT					Sender / Mandatory: ES checks the common rules & conditions Receiver / Strongly Recommended: FR checks the common rules & conditions This occurrence of the DG doesn't have any CC qualifier => Sender shall validate only common R/C/CL's must be validated
Sequence number = 1	R	n..5		R0987	
Type	R	an4	CL214	G0918	
CC qualifier = empty	D	a2	CL010	R0906 G0921 C0917	
Reference number	R	an..70		G0021	
---PREVIOUS DOCUMENT					Sender / Mandatory: ES checks the common rules & conditions Sender / Mandatory: ES checks the national rules & conditions Receiver / Strongly Recommended: FR checks the common rules & conditions This occurrence of the DG has the Sender CC qualifier => Sender shall validate BOTH common AND national R/C/CL's .
Sequence number = 2	R	n..5		R0987	
Type	R	an4	CL214	G0918	
CC qualifier = ES	D	a2	CL010	R0906 G0921 C0917	
Reference number	R	an..70		G0021	
---PREVIOUS DOCUMENT					Sender / Mandatory: ES checks the common rules & conditions Receiver / Strongly Recommended: FR checks the common rules & conditions Receiver / Mandatory: FR checks the national rules & conditions This occurrence of the DG has the Receiver CC qualifier => Sender shall validate common R/C/CL's; Receiver shall validate national R/C/CL's; Receiver can also validate the common R/C/CL's if it decides so.
Sequence number = 3	R	n..5		R0987	
Type	R	an4	CL214	G0918	
CC qualifier = FR	D	a2	CL010	R0906 G0921 C0917	
Reference number	R	an..70		G0021	



SUBMISSION PRIOR TO PRESENTATION OF GOODS

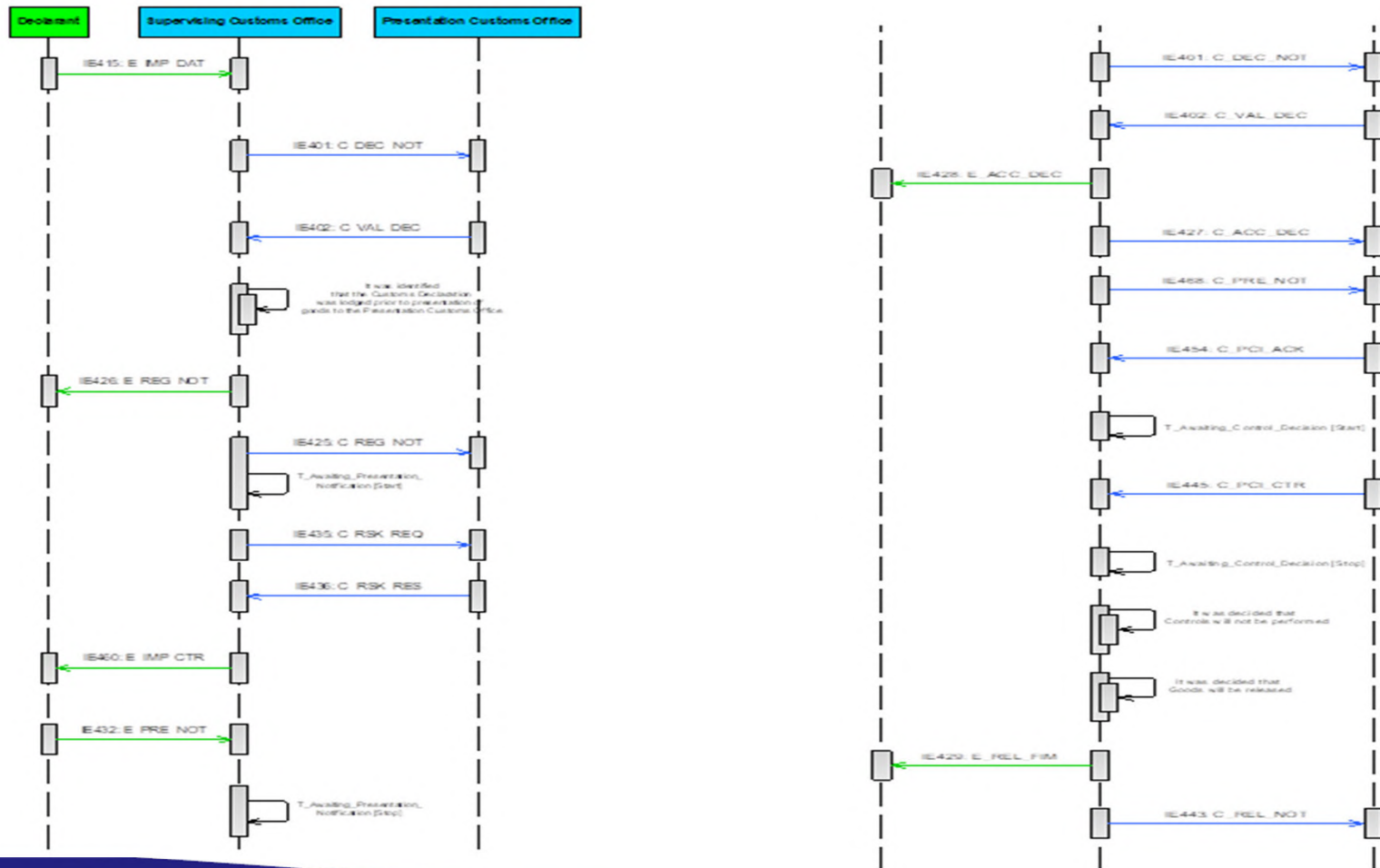

SENDING REQUESTED DOCUMENTS BY MESSAGE FOR CONTROL PURPOSES

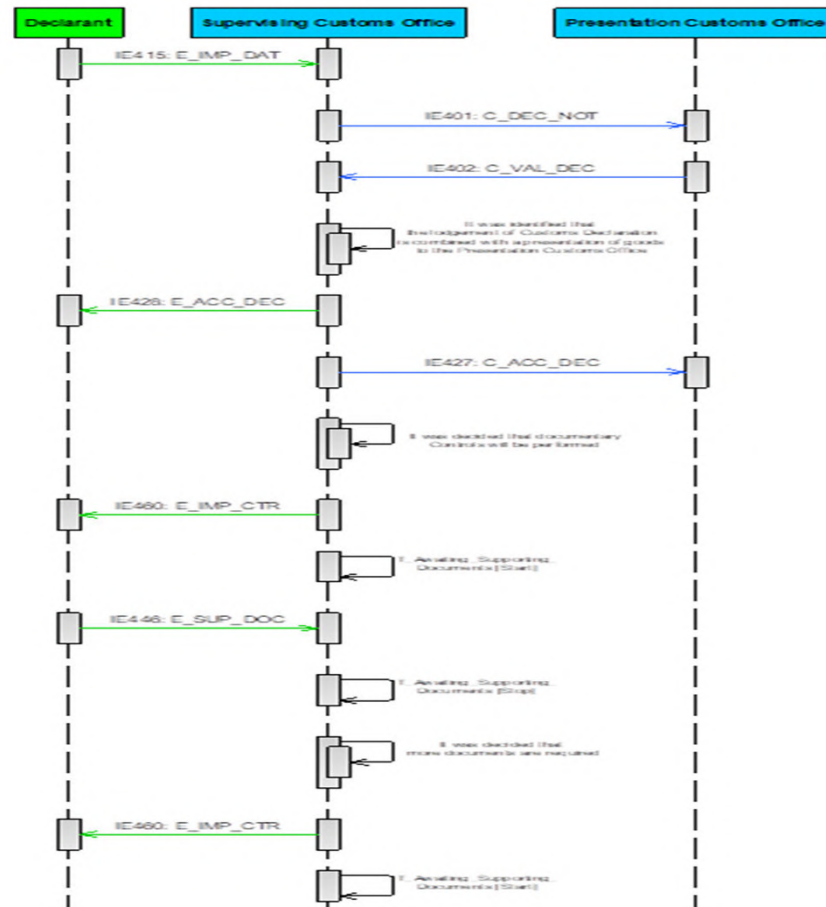



UCC CCI P1 E-LEARNING COURSE

A new e-Learning course for CCI P1 is under development within TAXUD

Cover two different roles:

- customs authorities
- economic operators.

Upcoming: Beginning of 2022

Customs and Tax EU Learning Portal: customs-taxation.learning.europa.eu



IDMS - CCI PHASE 1 TIMELINE

- IDMS
 - Sprint content will be published asap
 - ACC environment available
 - PROD : Nov 2022
- CCI :
 - Detailed planning to be drafted, but IDMS has priority
 - Prod :1/12/2023

NEXT STEPS

What to do to use the system?

- 1) Be Holder of CCI Authorisation at EU level or, appoint a Holder of CCI Authorisation, acting as your indirect representative
- 2) Update your IT systems with CCI specifications

What to do to prepare well?

- Contact your national customs authorities in respect of CCI
- Apply for AEO Authorisation
- Apply for CCI Authorisation

=> start in time!



Federale
Overheidsdienst
FINANCIEN

Thank you !

WWW.FIN.BELGIUM.BE

DOUANE EN ACCIJNZEN • FEDERALE OVERHEIDSDIENST FINANCIEN



Federal
Public Service
FINANCE

AUTOMATED EXPORT SYSTEM (AES)



WWW.FIN.BELGIUM.BE

CUSTOMS AND EXCISES • FEDERAL PUBLIC SERVICE FINANCE

.be



AUTOMATED EXPORT SYSTEM

- AES is the application that manages export operations, based on the exchange of electronic messages between
 - Economic operators and Customs (external domain)
 - Customs offices within a single member state (national domain)
 - Customs offices in different member states (common domain)
- It replaces and expands the existing Export Control System.



ECS TO AES - IMPACT ON MESSAGES

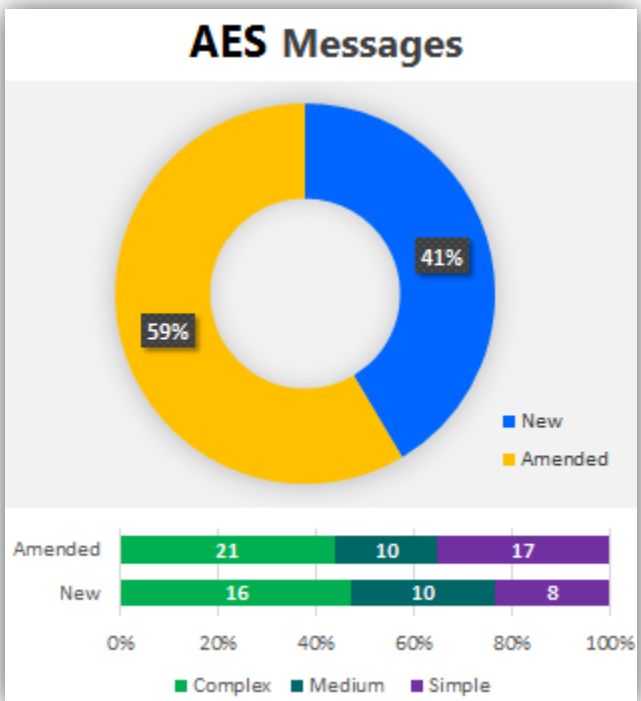



MESSAGE STRUCTURE

- Declaration layer (1x)
 - Involved customs offices and main economic operators, exchange rate, declaration identification
- Shipment layer (1x)
 - Documents, involved supporting parties,
- Consignment layer (1x)
 - Parties involved in transport and handling, transport equipment, location, ...
- Goods Item (9999x)
 - Information specific for a single goods item



ADDITIONAL REMARKS

- ‘Vak 44’ split in 4 separate fields with specific code lists:
 - Previous document
 - Supporting document
 - Additional reference
 - Additional information
- G0825: information must be recorded on the appropriate level
 - Applies for 4 fields above + Additional supply chain actor
 - Values that are identical for all goods items → Shipment level
 - If there is only one article → everything on shipment level
 - Consignment + consignment item information only apply to transit
 - This is the same rule that applies today



MESSAGE EXCHANGES: DECLARATION

- IE515: Declaration
 - IE556: Rejection
 - IE528: Acceptance

- IE560: Control decision notification
- IE529: Release for export
- IE551: No release

- IE599: exit of goods has been finalized at office of exit



AMENDMENT, CORRECTION, REGULARIZATION, INVALIDATION

- IE513 export declaration amendment
 - IE556 rejection from office of export
 - IE504 export declaration amendment acceptance
 - This exchange is used for all types of changes to the declaration
 - Instructions about required additional information to follow
- IE514 export invalidation request
 - IE556 rejection from office of export
 - IE509 export invalidation decision



MESSAGE EXCHANGES: EXIT PROCESS

- ECS

- Charge report → response
- CODECO → APERAK

- Manifest → response

- Transfer & confirmation

- AES

- IE507 arrival at exit
 - IE557: rejection from office of exit
 - IE521: diversion rejection
 - IE561: exit control decision notification
 - IE525 exit release notification
 - IE522: exit release rejection
- IE547: Manifest
 - IE548: Manifest validation
 - IE557: rejection from office of exit
- Explained elsewhere



OTHER MESSAGES

- Acknowledgement with correlation ID (IE928)
- Non acknowledgement due to xml errors (IE917)
- Exit confirmation by port authority: no changes
- Request on non exited export (IE582)
 - Information on non-exited export (IE583) with alternative evidence
 - These messages are low priority.
- Note: all aforementioned messages are sent via callback and are available for polling.

AES P1 TO INTERACT WITH SOME NEW SYSTEMS



- *Interface Status*
 - **Added: 6**
 - **Modified: 6**
 - **Unchanged: 3**



ECS TO AES – IMPACT ON PROCESSES

- New
 - Centralized Clearance for Export
 - Export followed by transit
 - Consolidation
- Modified
 - Transfer
 - Pre-lodged declarations (type D-E-F)
 - Amendment/correction of the declaration
 - Simplified declaration
 - Re-export notification (formerly transshipment)



CENTRALIZED CLEARANCE FOR EXPORT

- Goods presentation and verification in a different member state than declaration
- All communication with declarant via Supervising office (where declaration has been submitted)
- No change in message flow from declarant's perspective



OTHER NEW/MODIFIED PROCESSES

- Export followed by transit
 - ECS: exit movement stops when transit operation started
 - AES: exit movement stops when transit operation is finalized
- Consolidation
 - Arrival at exit (IE507) + code for notifying consolidation
 - Verification happens at consolidator's premises
 - No supplementary risk analysis upon arrival at terminal
 - No need to register and cancel an arrival just to check issues with MRN
- Transfer (only used at airports)
 - No longer a separate message
 - IE507 + code for notifying or accepting transfer

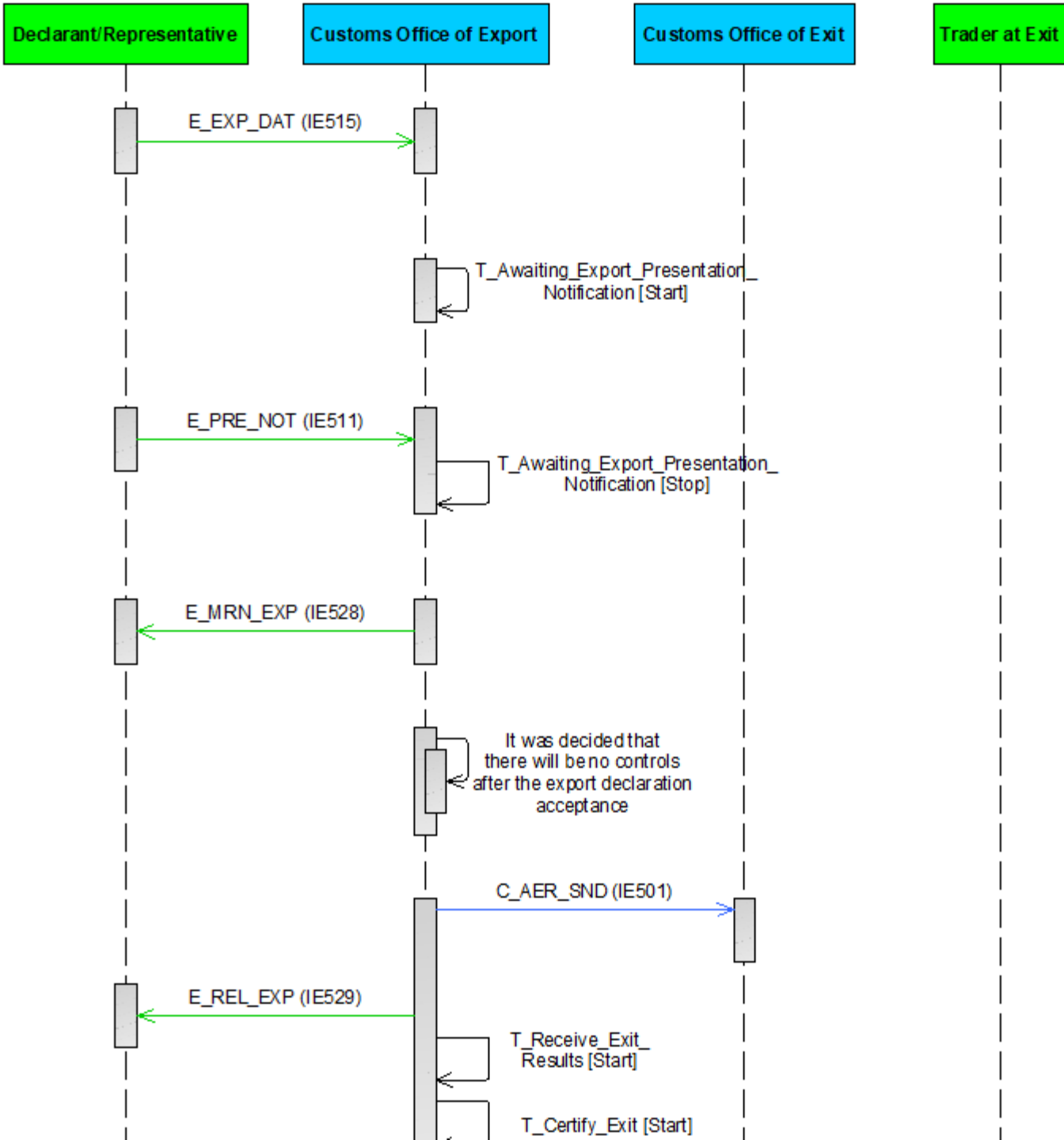

OPERATIONS





OTHER MODIFIED PROCESSES

- Amendments/corrections
 - will be requested via IE513 message.
 - If accepted → new version with the same MRN/LRN (IE504)
- Simplified declaration
 - Supplementary declaration reminder is now an electronic message
- Re-export notification (transhipments)
 - New process for notification and invalidation (no amendment)
 - Can be selected for verification
 - Handled via temporary storage systems rather than AES, same as mini-CUSCAR functionality
 - Exit process is tracked via AES, same as in ECS



SPECIAL MENTION

- Exit procedure with single transport document
 - Initiated with IE507 message with specific code
 - Code to be specified by legal department
 - Further exit process remains the same as ECS



MESSAGE IMPLEMENTATION GUIDE UPDATES

- https://financien.belgium.be/nl/douane_accijnzen/ondernemingen/applicaties-da/aes
- Information can change once a year (change release management from European Commission)
- Last updates published on 05/11/2021
- Minor national changes can be published more often (like implementation of a national rule)
- One upcoming update with minor national additions (language field)



MESSAGE IMPLEMENTATION GUIDE CONTENT

- EO Notification Gateway description → to be added
- DDNXA
- Message scope (annex A)
- Technical message structure, rules, codelists (annex Q2)
- Codelists themselves are being prepared by legal department
- Rules and conditions mapping (annex K) → Deviations will be listed in a separate file
- XSD schema's (Annex X) → Will be replaced by final Belgian version
- Any other documentation requested by traders (eg location code identification)



TRANSITION – PARALLEL RUN

ECS



Declarations and
exit operations
fully in PLDA

Transition



New declarations in AES

Customs responses to old
declarations in AES

Exit operations remain in PLDA
(old messages)

AES

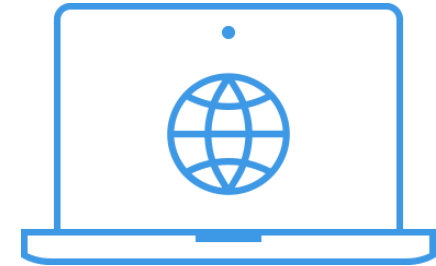

Declarations and
exit operations
fully in AES



NEXT STEPS

- You can start your analysis based on EU documentation on site. Adaptations will be minimal
- As soon as we have the finished XSD format from our contractor, we will publish it. This will include the yet to be published version of the DDNXA. Do not wait for this document to start analyzing/developing.
- Our development is agile. First priority: test environment where economic operators can send IE515 and receive reply. Verification and interfaces will be added later. Date: TBD by our contractor and IT department.
- Go live date of declaration: Q1 2023 (declaration, invalidation, amendment)
- Go live date of exit process: TBD



QUESTIONS RECEIVED FROM TRADE

- Moving away from paper procedures
 - No more PDF's
 - Reduced downtime to reduce emergency procedures
 - Any visual representation will show the EU Customs Data Model format rather than the old 'vak x' structure.
- Electronic autograph/envelope
 - All security aspects are managed by the EOGW/FEDIAM to exchange messages with customs or use the web app.



QUESTIONS RECEIVED FROM TRADE

- Country of routing does not include countries of departure or destination
- No more use of document 'category'. Belgium uses European codes unless otherwise specified in MIG or legal annex
- No initiatives for e-commerce until further notice



Federal
Public Service
FINANCE

